

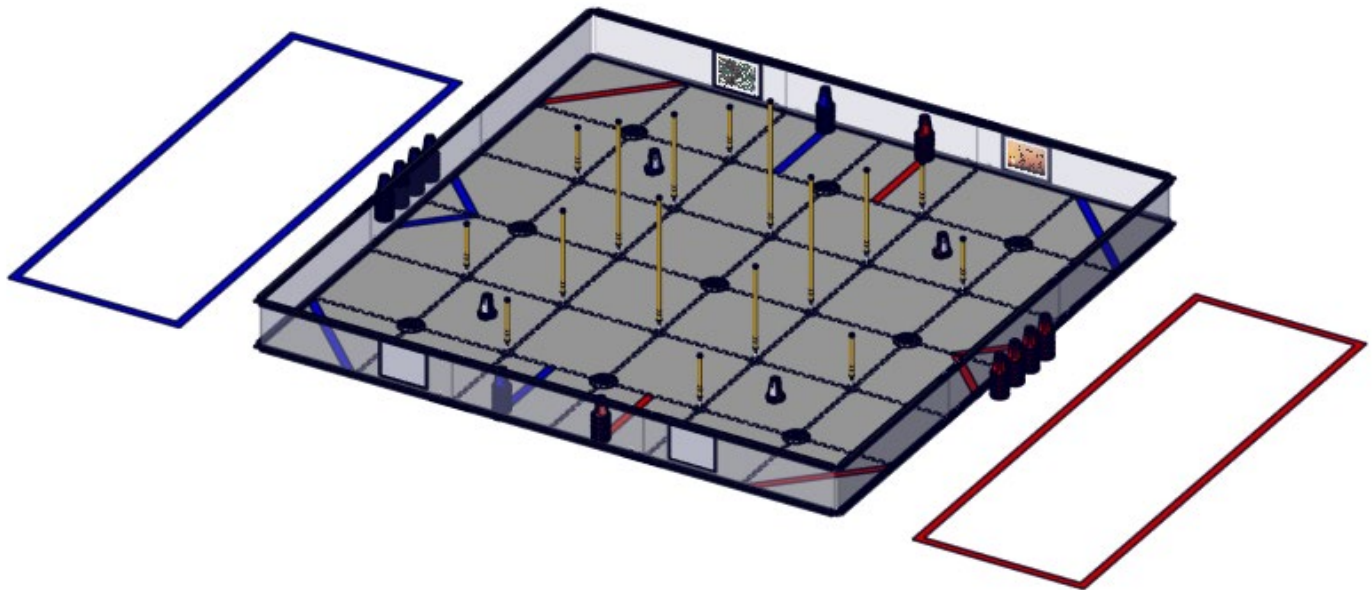

2022-2023 POWERPLAYSM
presented by Raytheon Technologies

2022-2023 FIRST[®] Tech Challenge
Field Setup Guide







Rev 1.1











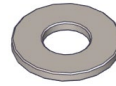

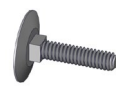

**This guide contains instructions for setting up the Field Elements for the
2022-2023 FIRST® Tech Challenge Game
POWERPLAYSM presented by Raytheon Technologies**

Read through all the instructions and take a parts inventory before you begin to assemble and setup the game elements!



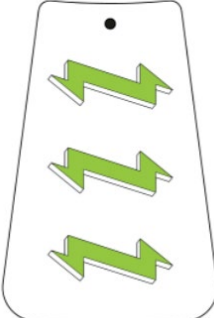

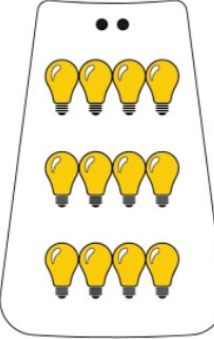

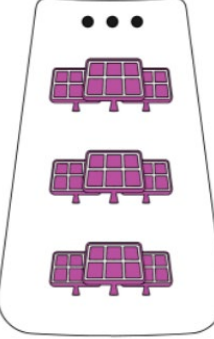

REVISION HISTORY		
Rev.	Date	Description
1.0	8/31/2022	Public Release
1.1	9/8/2022	Remote and Partial Field Layouts Added

TOOLS NEEDED		
Component	Quantity	Part Photo
Safety Equipment	As Needed	
Utility Knife	1	
Tape Measure	1	
Color Printer	1	
Diagonal Cutters	1	
Ball end driver, screwdriver, or similar hand tool for inserting the rubber stopper	1	

Component	Part #	Full Field Total Quantity	Partial Field Total Quantity	Part Photo
Cap for Pole	am-4810	16	11	
High Pole	am-4809	4	3	
Medium Pole	am-4808	4	2	
Low Pole	am-4807	8	6	
Small Washer	am-1027	16	11	
Rubber Stopper	am-4806	16	11	
1" Fender Washer	am-1421	16	9	
Spring Assembly	am-4805	16	9	
Hex Head Cap Screw 1/4-20 x 1500 (this will not be used)	am-1630	16	11	
Hex Head Cap Screw 1/4-20 x 3500	am-1605	16	11	
Ground Junction	am-4802	9	6	
Elevator Bolt	am-1629	16	9	
3" Fender Washer	am-1628	16	9	
3-Hole Under Tile Disk	am-4804	25	15	
Cable Ties	am-1631_1	20	10	

Red/Blue Cone	am-4801_Red/Blue	32 Red AND 32 Blue	32 Red OR Blue	
 Cone Sticker	am-4803	4	2	
 Cone Sticker		4	2	
 Cone Sticker		4	2	

Part 1: Junction Assembly

Junction Assembly					
Component	Part #	Quantity Per Assembly	Full Field Total Quantity	Partial Field Total Quantity	Part Photo
Cap for Pole	am-4810	1	16	11	
High Pole	am-4809	1 pole	4	3	
Medium Pole	am-4808		4	2	
Low Pole	am-4807		8	6	
Small Washer	am-1027	1	16	11	
Rubber Stopper	am-4806	1	16	11	
1" Fender Washer	am-1421	1	16	11	
Spring Assembly	am-4805	1	16	11	
Hex Head Cap Screw 1/4-20 x 3500	am-1605	1	16	11	

Junction Assembly: The junction assembly can be performed by hand. The assembly steps are the same for all pole lengths. A full field will have 25 total Junctions: 4 High, 4 Medium, 8 Low, and 9 Ground.

Remove any extra burrs or particles from the ends of the pipe.

1. Insert the Cap for Pole into the end of one of the pipe until fully seated.

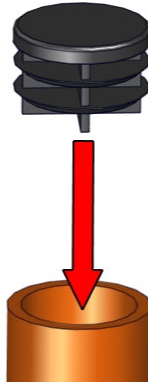

NOTE:

Two lengths of screws are provided. Use the 3.5" long Hex Head Cap Screw (am-1605). The shorter screw is not necessary for this assembly and can be discarded.



2. Insert Hex Head Cap Screw $\frac{1}{4}$ -20 x 3500 through the Small Washer and into the small end of the rubber stopper.

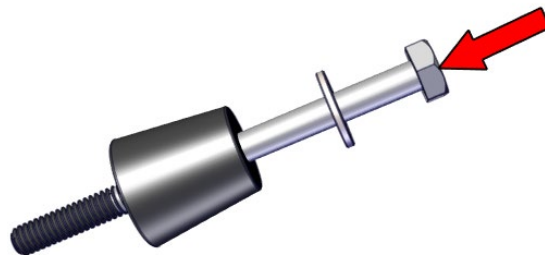

3. Push the small end of the rubber stopper completely into the pole using a ball end driver or other similar tool. Press around the edges of the rubber stopper to ensure that it is **inserted straight** and that the screw exits parallel to the pole.

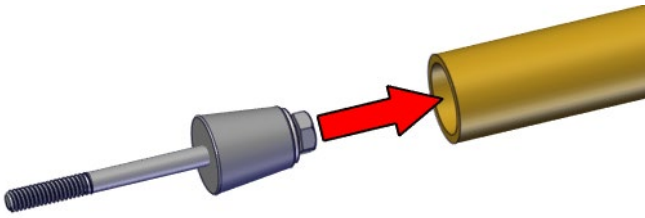

Note: Wear gloves for safety and be careful while inserting stoppers!

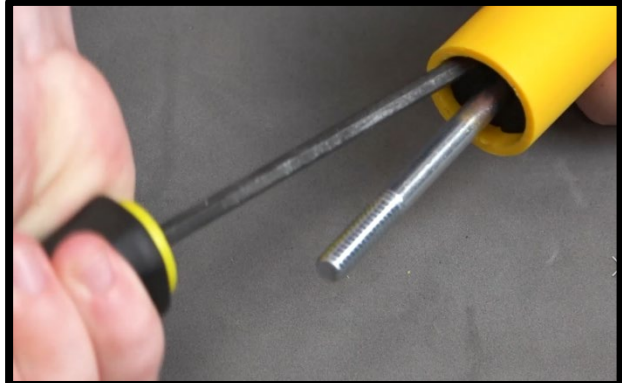

Note: It is effective to firmly push around the edge of the stopper with a ball end driver or other tool.

Note: When fully inserted the end of the screw should stick out **approximately 9/16"**, which can be measured by the head of the Hex Head Cap Screw 1/4-20" x 3500.

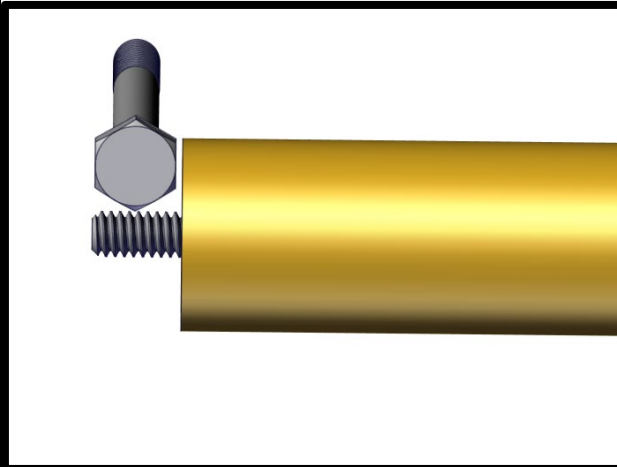

4. Place the 1" fender washer on the protruding screw.

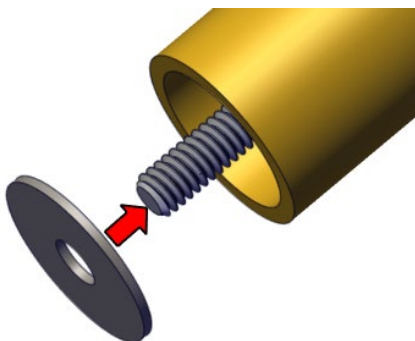

5. By hand, thread the spring assembly onto the protruding screw. Tighten the Spring Assembly until it stops.

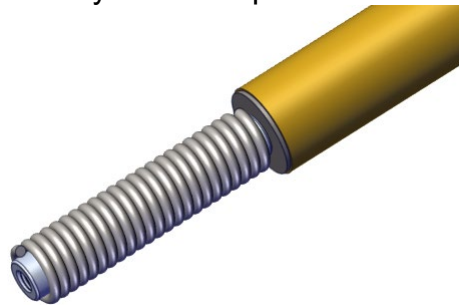

Caution: Watch for sharp edges.

Repeat Steps 1-5 for all remaining poles and set aside for field assembly.

Part 2: Game Piece Preparation

On a full field, two red and two blue cones will have stickers on them. Install the stickers in the following locations:

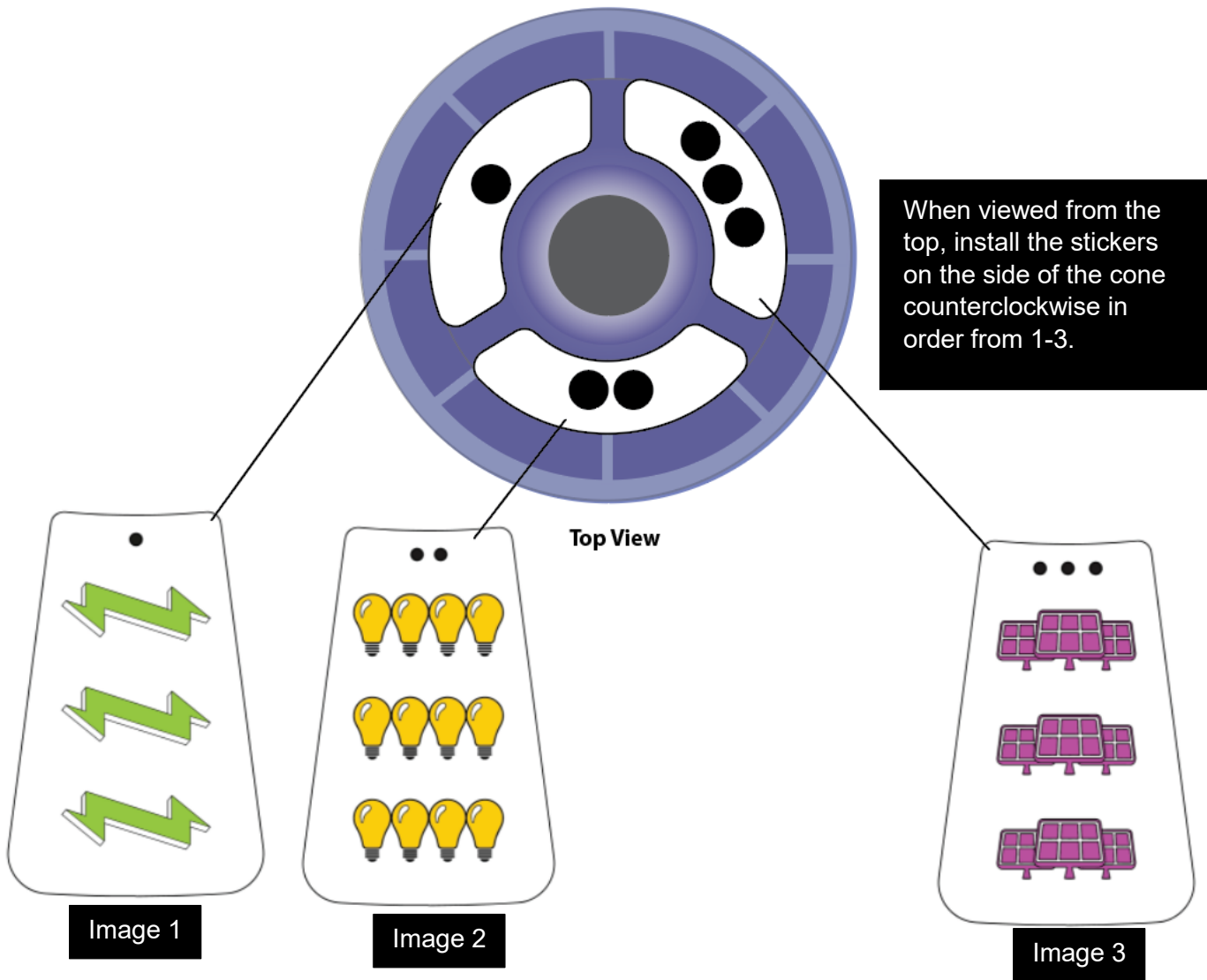







2x

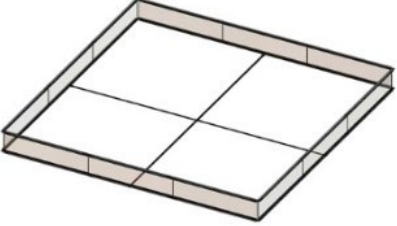



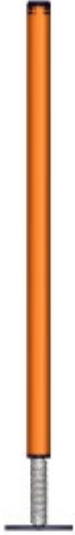
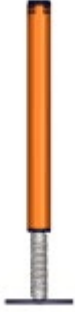

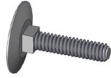
2x

Part 3: Competition Field Requirements

FULL FIELD REQUIREMENTS			
Component	Part #	Quantity	Part Photo
FIRST Tech Challenge Field Perimeter	am-0481b or similar	1	
5/8" Gray Soft Tiles	am-2499 or similar	36	
Competition Field Components			
Component	Part #	Quantity	Part Photo
High Junction	Keep Assembled	4	

Medium Junction	Keep Assembled	4	
Low Junction	Keep Assembled	8	
Ground Junction	am-4802	9	
Elevator Bolt	am-1629	16	
3" Fender Washer	am-1628	16	
3-Hole Under Tile Disk	am-4804	25	

Cable Ties	am-1631_1	9	
Red Cone	am-4801_red	30	
Blue Cone	am-4801_blue	30	
Red Signal	Cone (am-4801) with Stickers (am-4803)	2	
Blue Signal	Cone (am-4801) with Stickers (am-4803)	2	

Competition Field Components

Not included in Game Set

2" "Red" Gaffers Tape	am-2946	as needed	
2" "Electric Blue" Gaffers Tape	am-2947	as needed	
Cardstock for Navigation Image (Printed from FIRST Resource Library)	White 8.5x11" or A4 (international)	8	
Velcro® Dots	Roughly 3/4" diameter or larger	1 pack	
Clear Page Protection Sleeves	Similar to Staples P/N 40713	4	

Part 4: General Field Layout

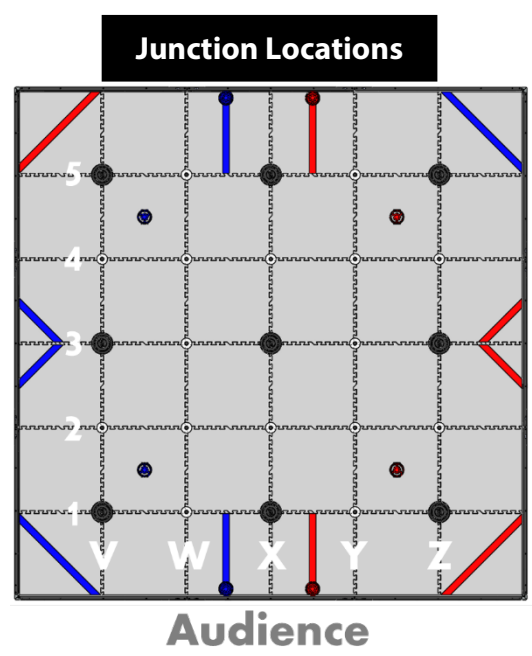
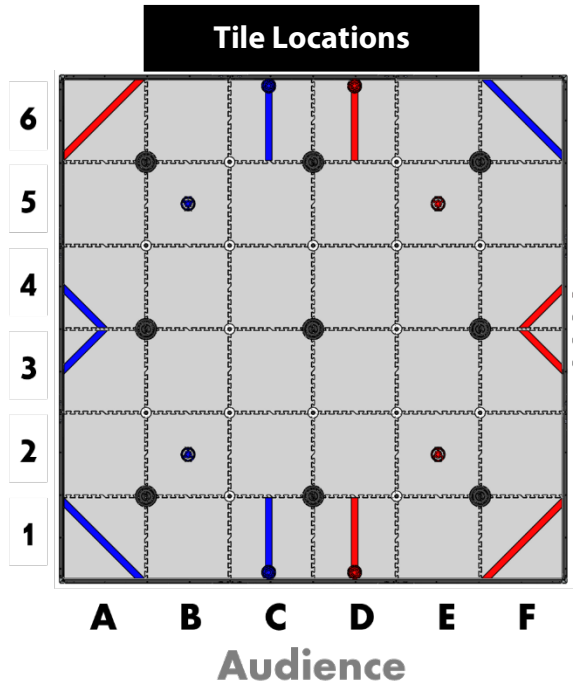
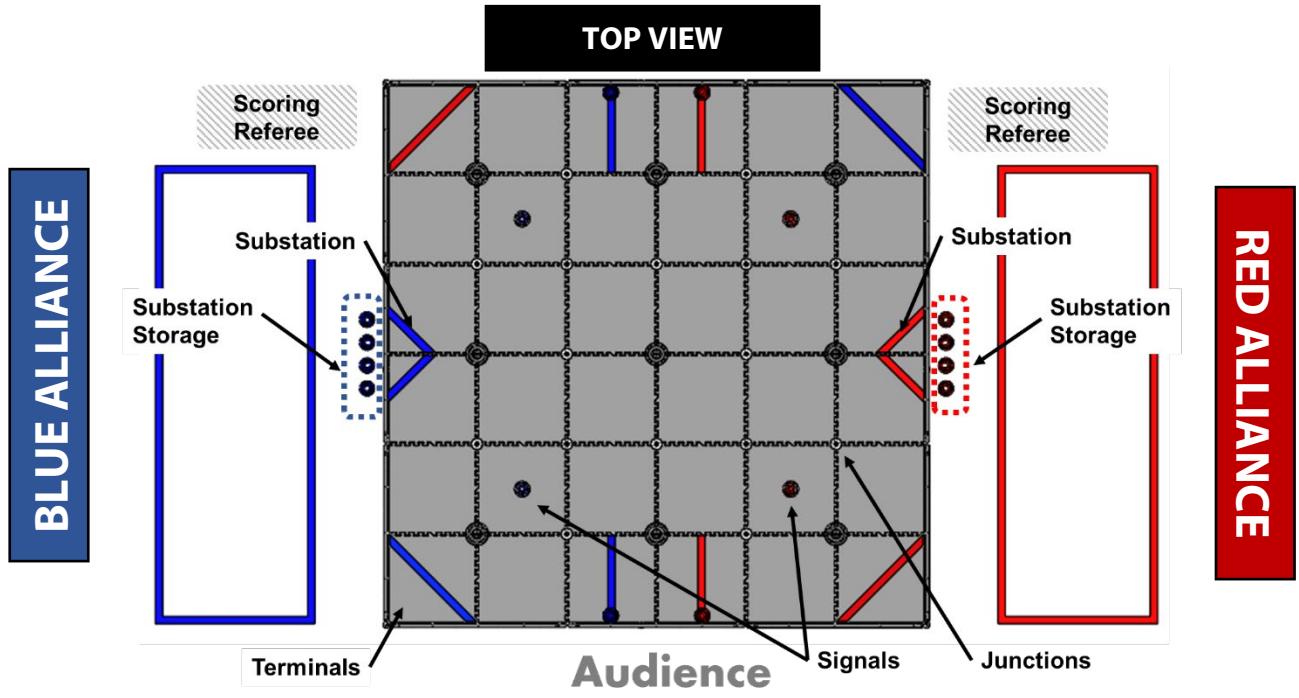

Part 5: Setting up the Floor and Field Perimeter

1. Lay the tiles with the **smooth** surface facing up in a 6x6 grid pattern.

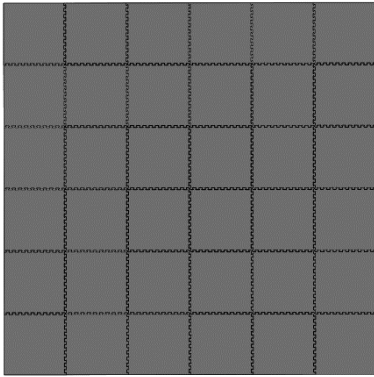

2. **Critical Mandatory Step:** Trim all outer tabs from the 20 Soft Tiles on the outside edges of the field.

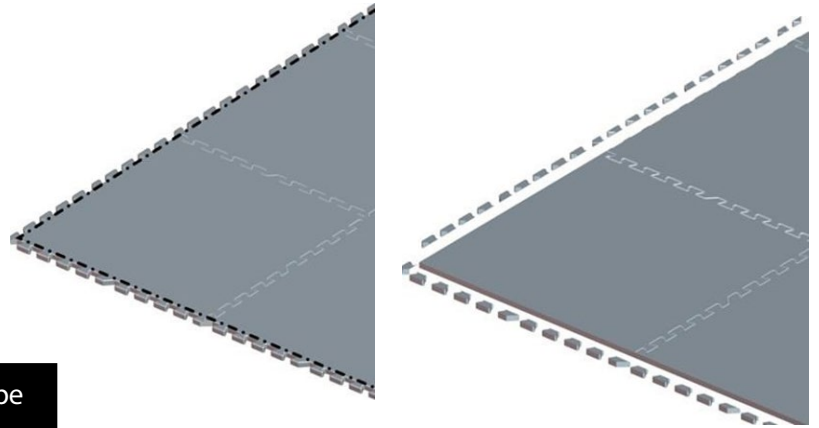

NOTE: Lay the tiles out and mark the outer edge to be cut. Use a sharp utility knife and a straight edge or a band saw (if available) to get a smooth clean edge.

NOTE: If using the AndyMark Field Perimeter, ensure that straps are installed to keep walls in place during game play.

3. Note that there are several **FIRST** Tech Challenge Perimeter wall designs. The wall designs fall into two categories. The smooth/non-cavity sides should face towards the inside of the Playing Field as shown in the illustration.

Perimeter	Wall Design Categories	Wall Height
AndyMark (current)	Smooth on one side and an open cavity on the other side	12.125"
IFI Perimeter	Smooth on one side and an open cavity on the other side	11.5"
Logo Loc Perimeter	Symmetrical inside and outside surfaces	12.375"

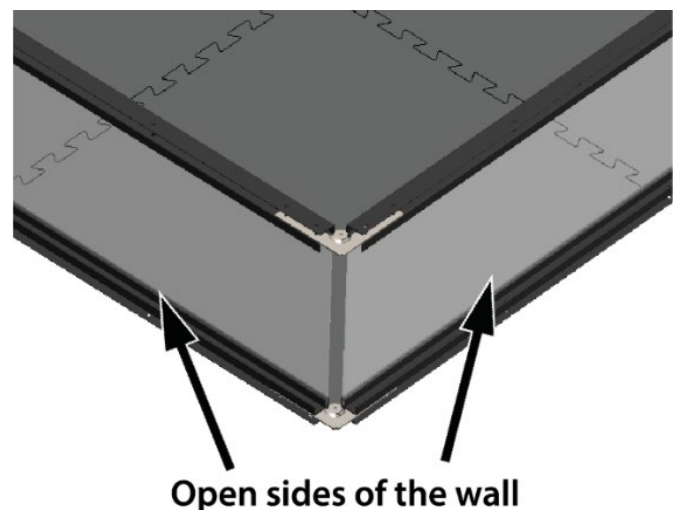
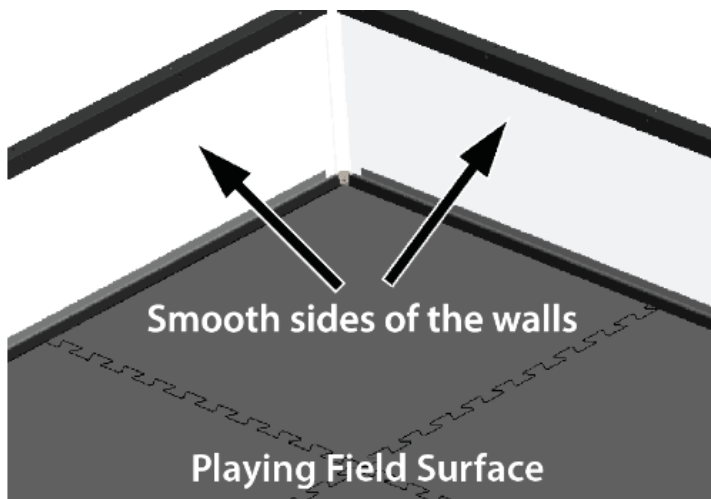

Part 6: Junction Installation

Junctions are installed in the following locations for a full field setup.

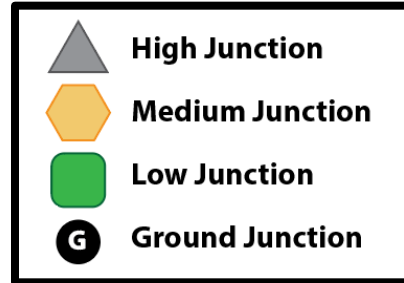
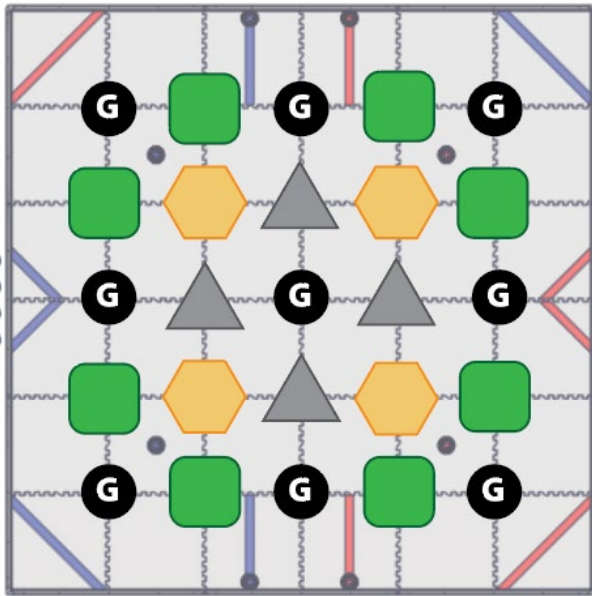

Ground Junctions

Ground Junctions are installed at the intersection of tiles in the following locations. Ensure they are all facing the same direction.

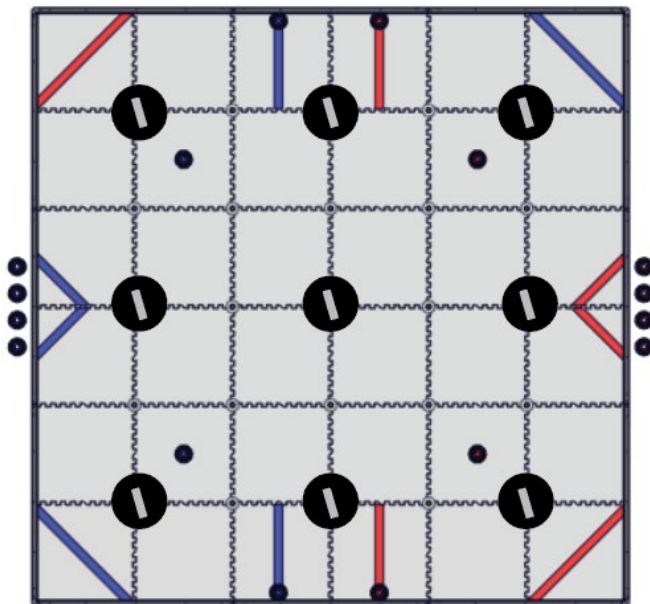

AUDIENCE

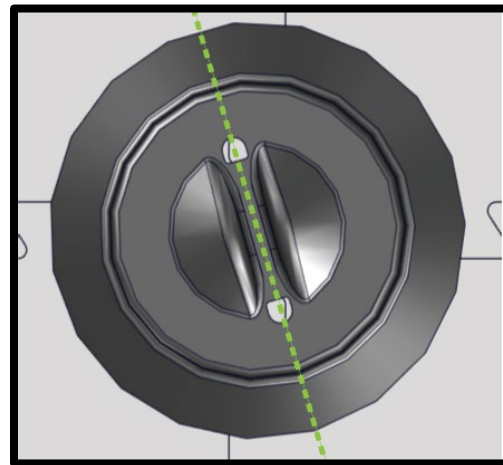

1. Place a single cable tie through both outer two holes in the Under Tile Disk

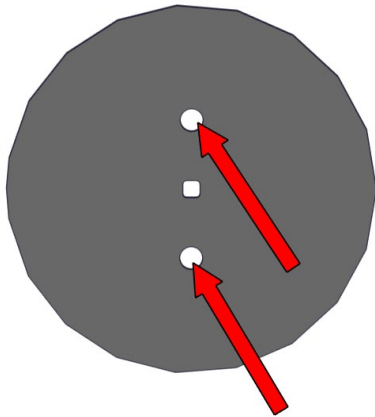

2. Slide the disk under the tiles and pull the cable tie through the tile and Ground Junction. **Ensure the cable tie is in the same orientation on each ground junction** running from the top left corner to the bottom right corner when viewed from the audience.

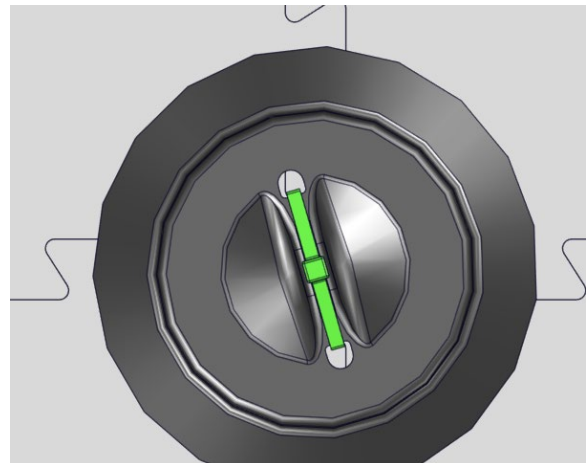
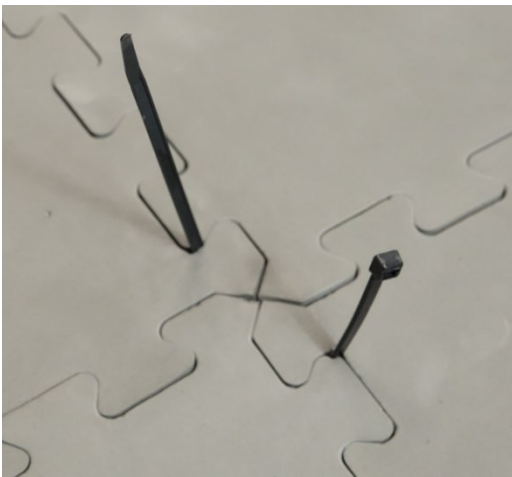

Cable tie should point from approximately 11 o'clock to 5 o'clock.

3. Tighten the cable tie and trim the end. Ensure the head of the cable tie sits in the center of the channel of the Ground Junction.

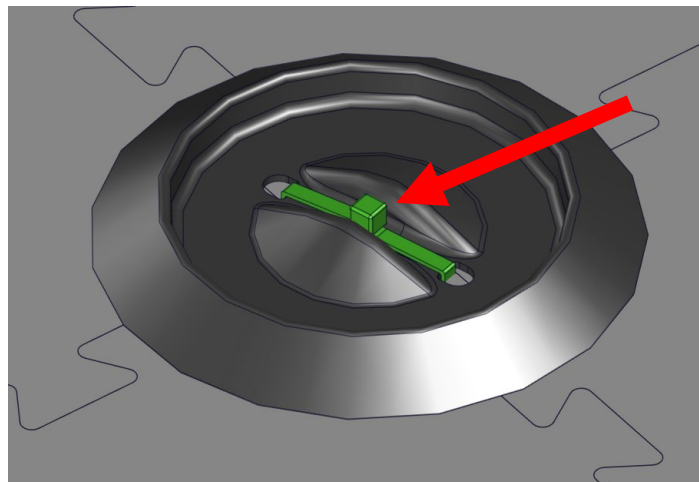

High, Medium, & Low Junctions

1. Place an elevator bolt through the center hole in the Under Tile Disk. The square section of the bolt should fit into the square hole in the disk.

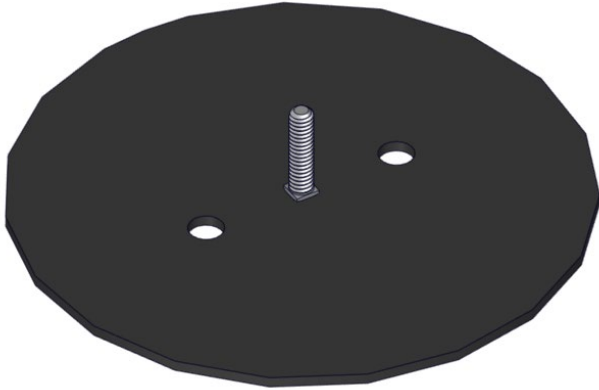

2. Slide the disk under the tiles and reconnect the tiles so that the Elevator Bolt protrudes from the center of the intersection.

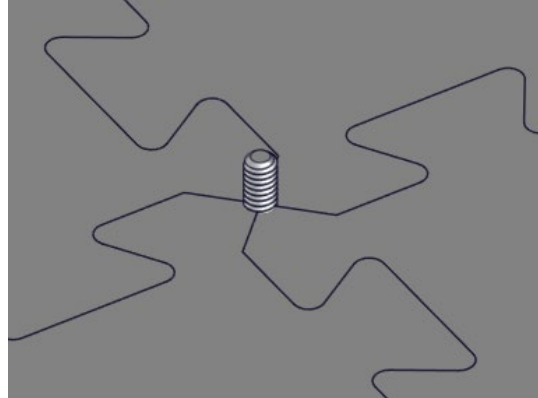

3. Place a 3" Fender Washer onto the Elevator Bolt.

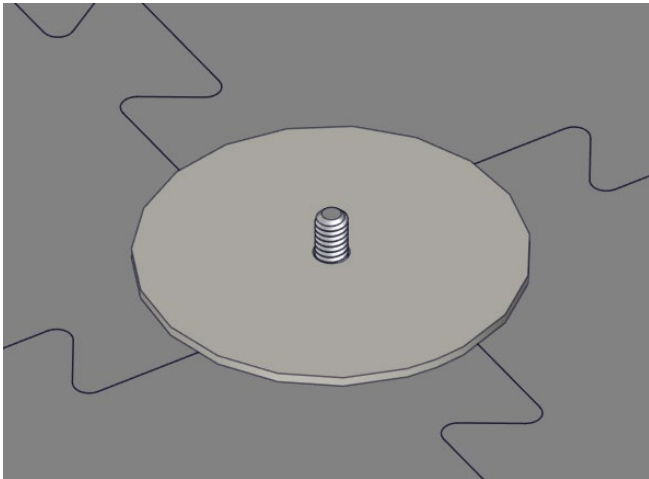

4. Screw the Junction Assembly onto the elevator bolt. Tighten by hand until the 3" Fender Washer presses into and sits flush with the top of the tile.

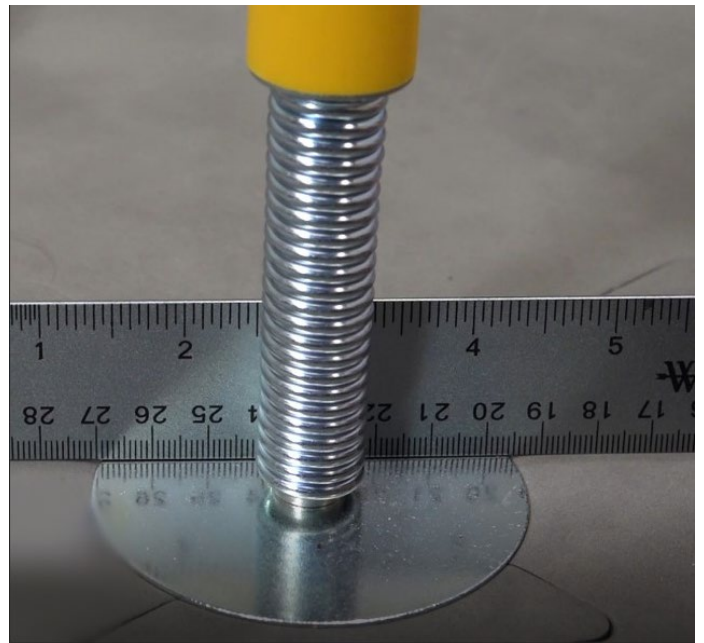

Part 7: Tape Lines

Tape lines for the field are as shown. All solid lines on and around the field are made with 2" wide red or blue Gaffers Tape. Dotted lines around the Substation Storage do not require tape. There is also a need for a Referee Question Box close to the field area.

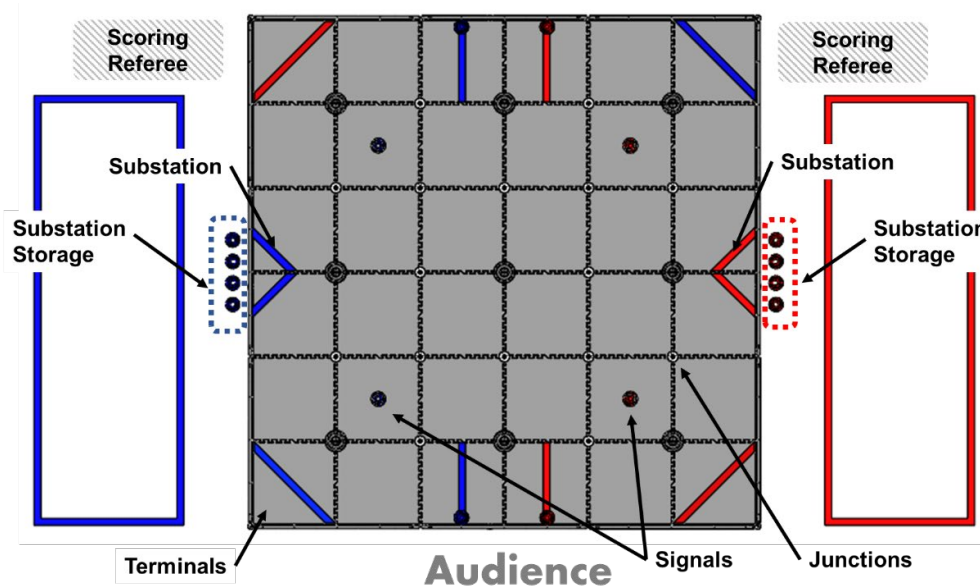

Terminals

Terminals are located at the 4 corners of the playing field. The terminals are marked with a diagonal tape line with dimensions as shown.

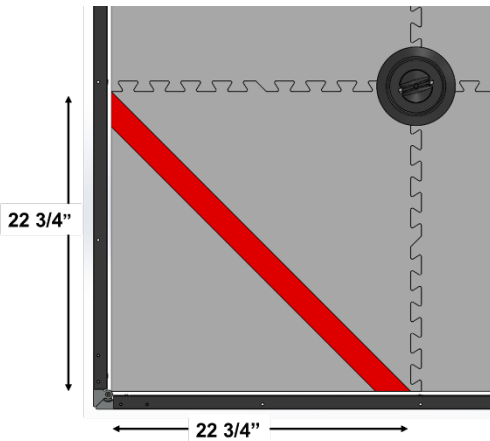

Substations

Substations are located along the walls closest to each alliance station. The substations are marked with two diagonal tape lines with the dimensions as shown.

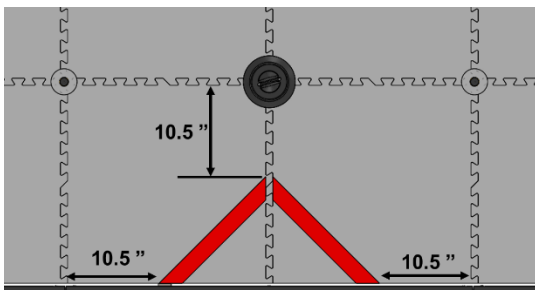

Signal Line

Locations for signals are marked with tape located on the second tile in from each side. Tiles B2 and B5 should be marked with a blue line. Tiles E2 and E5 should be marked with a red line. The tape should measure approximately 2x4" and be centered on the tile with the long edge parallel to the driver station. The long edge should measure 10.5" away from the near edge of the tile seam. The short edge should measure 9.38" away from the near edge of the tile seam.

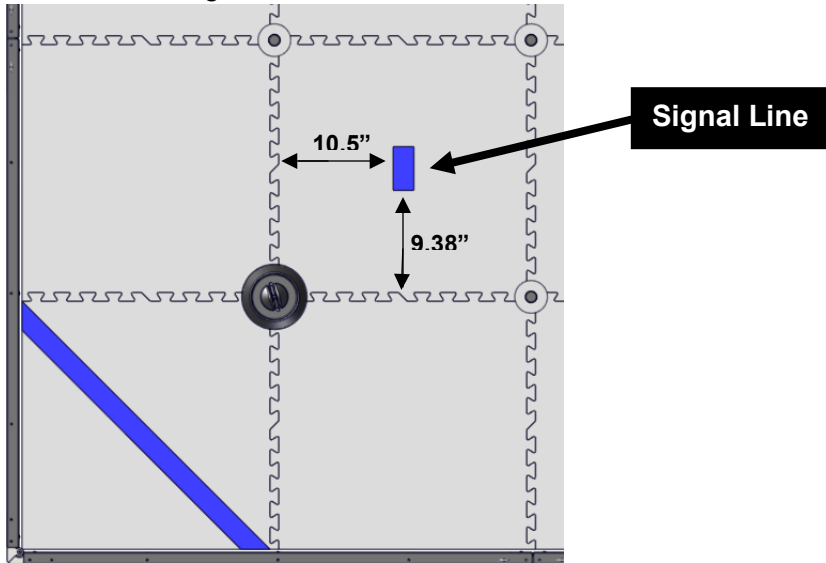

Cone Stack Line

A line of tape bisects the third tile in along both the audience facing wall and the far wall the distance between the edge of the tape and the near edge of the tile seam should measure 10.5". Tiles C1 and C6 should be marked with a blue line. Tiles D1 and D6 should be marked with a red line.

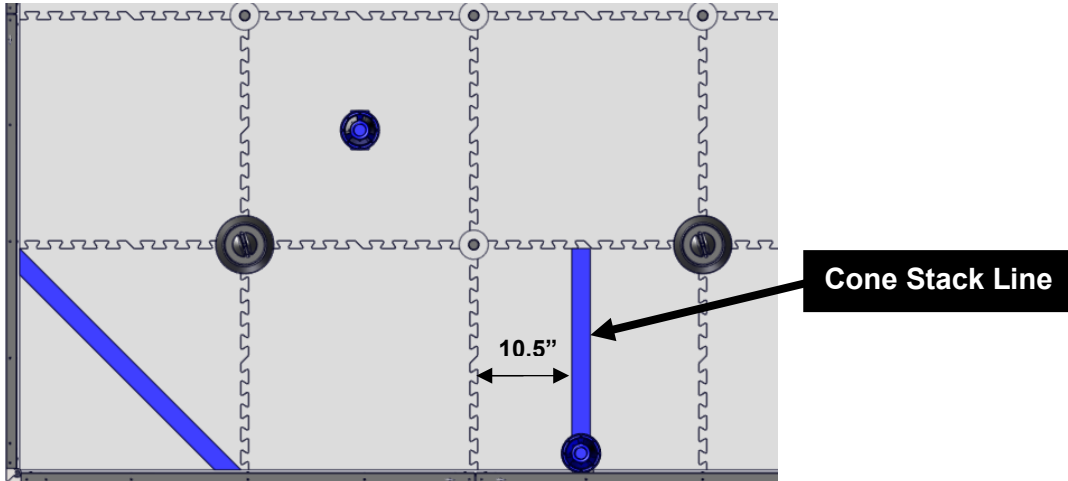

Alliance Stations

Alliance Stations are 10 feet (120") wide x 3.5 feet (42") deep. When viewed from the audience, the Blue Alliance Station is on the left side. The Alliance Stations are located 1.5 feet (18") away from the field perimeter.

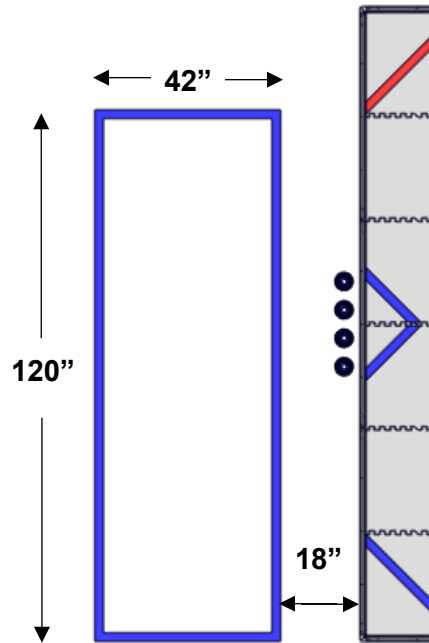

Referee Question Box



The Referee Question Box is a place where Teams can ask questions of the Referees after a Match.

The Referee Question Box must be placed in the Competition Area in a location where it will not interfere with the current running Matches, but close enough that the Referees will be able to see a student waiting at the Question Box. The Question Box can be as simple as a 3 x 3 foot Gaffers Tape square on the floor.

Part 8: Navigation Image Placement

1. Download the Navigation Image file, along with POWER PLAY logo template found on the FIRST Tech Challenge Game and Season Info Page:

<https://www.firstinspires.org/resource-library/ftc/game-and-season-info>



2. Print the downloaded images in color, not greyscale, on 8.5x11" or A4 White Cardstock. The Print resolution must be at least 300DPI.



3. Place the navigation images and logos in the plastic sleeves. A logo and navigation target image will be placed back to back so that each is visible on one side and upright when the sleeve is in landscape orientation.



4. Use Velcro dots in the top corners of the navigation target to secure to the outside of the field perimeter. Refer to the next step for specific image placements.



5. There are four Navigation Images placed around the field as shown. Each image has lines around the edge indicating vertical and horizontal center. The images are labeled corresponding to the centers of the tile nomenclature listed. Each image also has text with its placement location. The navigation images will face into the playing field and the logos will face away from the playing field. Navigation Images should always be placed as follows:

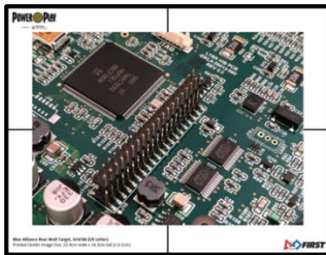

Image B6
Blue Alliance Rear Wall

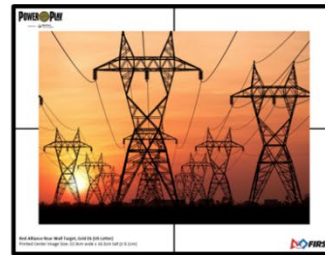

Image E6
Red Alliance Rear Wall



Image B1
Blue Alliance Audience Wall

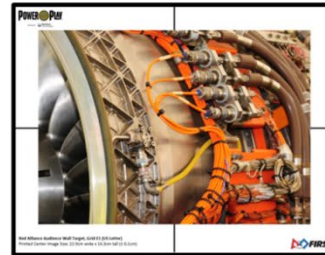

Image E1
Red Alliance Audience Wall

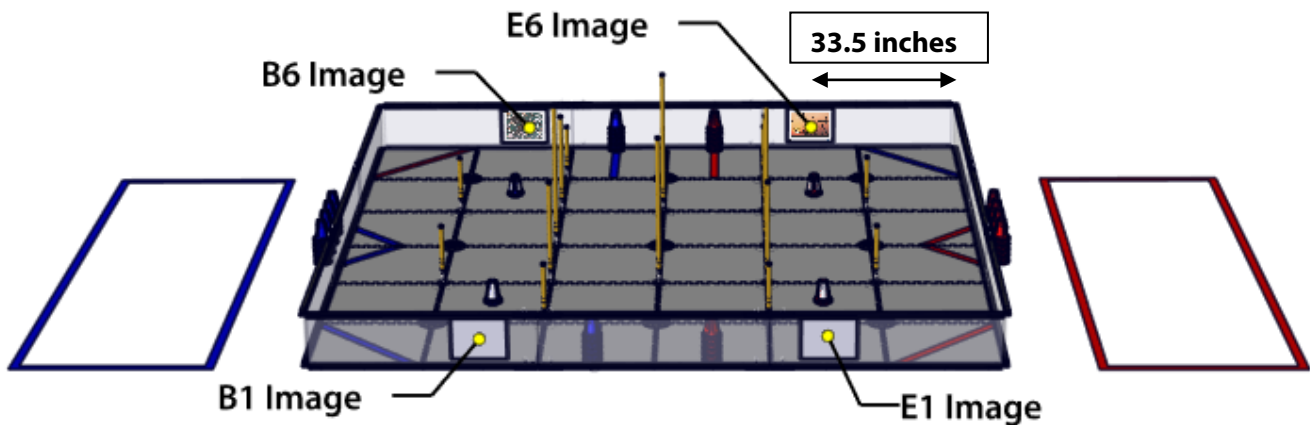

Image B1 – The center of the image is on the *Playing Field Wall* closest to the *Audience* and is aligned to the center of the second *Tile* in from the blue *Alliance Station*.

Image B6 – The center of the image is on the *Playing Field Wall* opposite of Image B1 and is aligned to the center of the second *Tile* in from the blue *Alliance Station*.

Image E1 – The center of the image is on the *Playing Field Wall* closest to the *Audience* and is aligned to the center of the second *Tile* in from the red *Alliance Station*.

Image E6 – The center of the image is on the *Playing Field Wall* opposite of Image E1 and is aligned to the center of the second *Tile* in from the red *Alliance Station*.

The Navigation Image horizontal center line should measure 6.375 inches to the floor (5.75 inches from the top of the tile). The Navigation Image should be placed 33.5” from the inside corner of the field to vertical center line on the Navigation Image.

Part 9: Game Piece Placement

Prior to the match, the game pieces should be placed in the following locations:

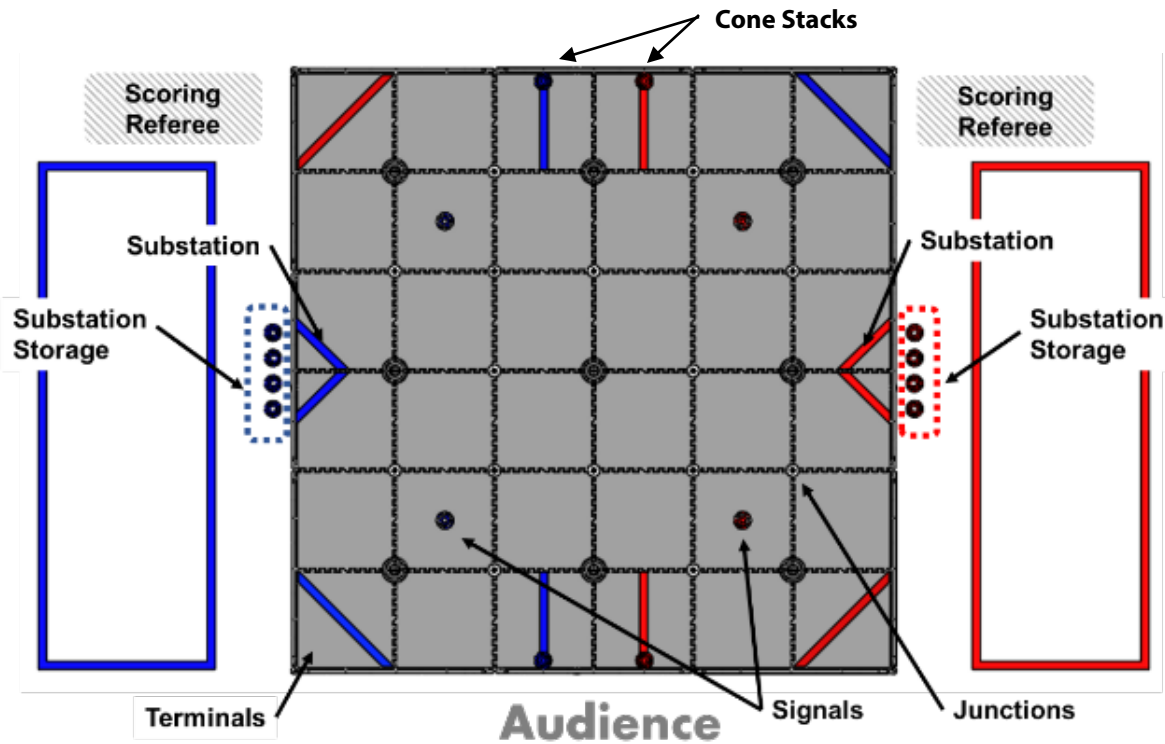

1. One (1) *Signal* is placed at each *Signal* location with image 1 facing the closest *Alliance Station*.

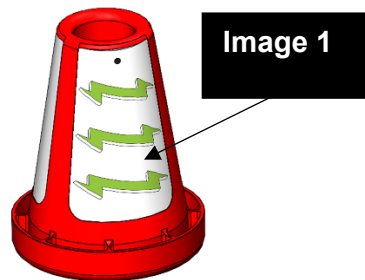



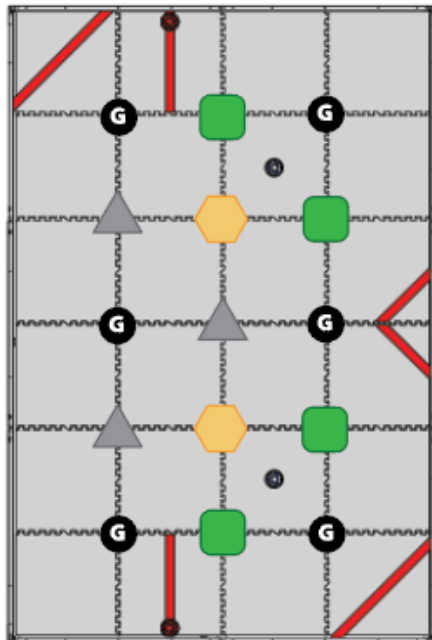
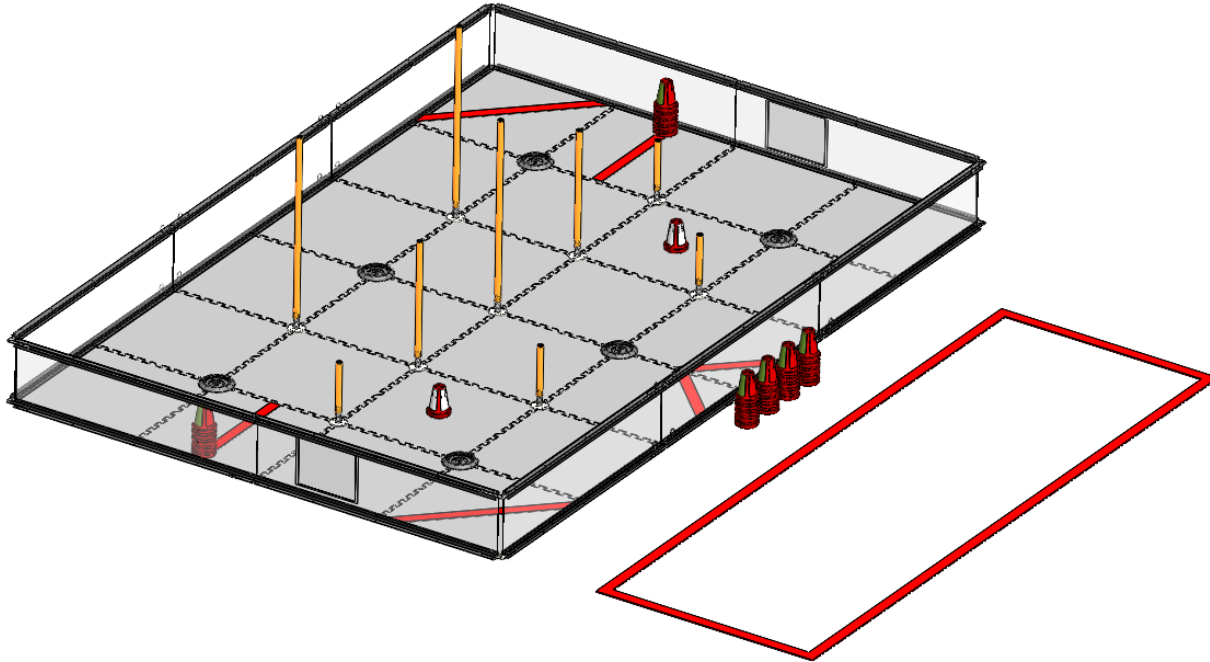

2. Ten (10) red Cones are placed in two (2) stacks of five (5) Cones each *Inside* the *Playing Field*.
3. Ten (10) blue Cones are placed in two (2) stacks of five (5) Cones each *Inside* the *Playing Field*.
4. Twenty (20) red Cones are placed in four (4) stacks of five (5) Cones each in the red *Substation Storage Area*.
5. Twenty (20) blue Cones are placed in four (4) stacks of five (5) Cones each in the blue *Substation Storage Area*.

Part 10: Partial Field Setup

Partial fields are offered as a cost saving solution for teams that would like to practice at home, school, or robotics lab to prepare for a traditional, in-person style tournament. The following image shows the Junction placement for the partial field set. For teams that are competing **remotely**, the Junction layout is different. Please see **Part 11 of this guide** for the correct Junction placement for remote style competition.





	High Junction
	Medium Junction
	Low Junction
	Ground Junction

Part 11: Remote Field Setup

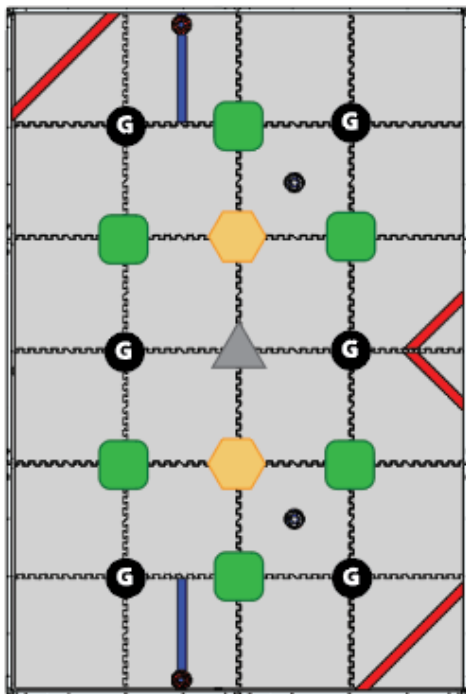
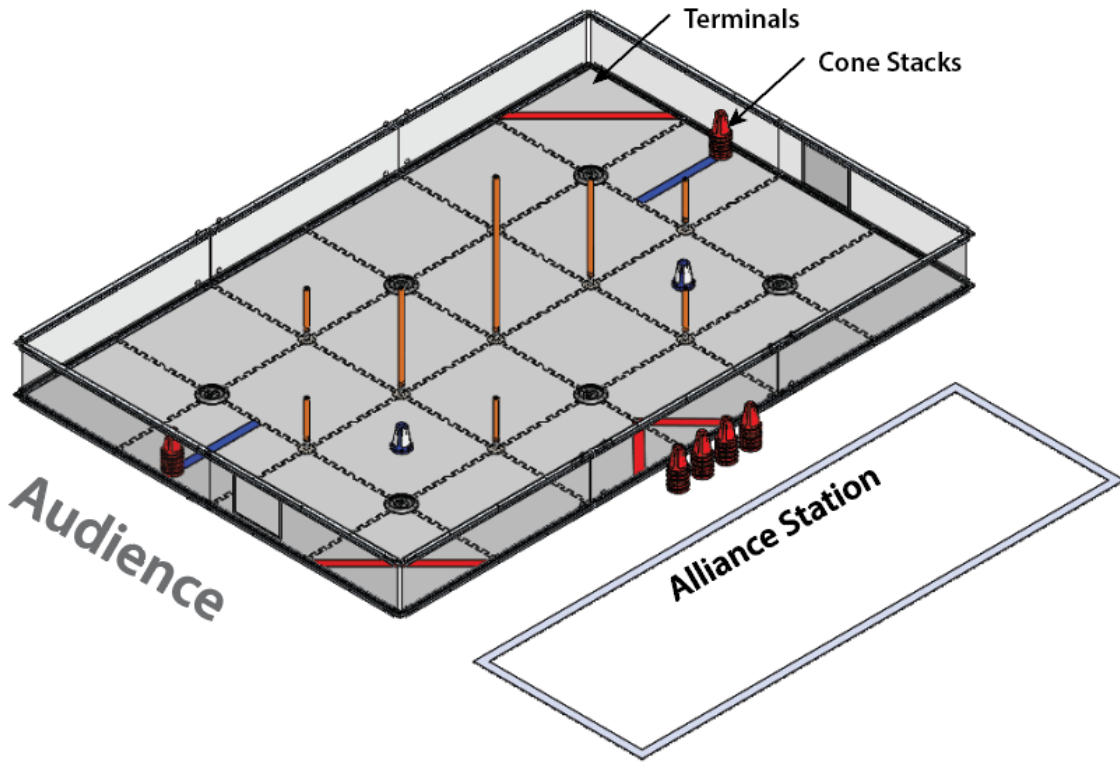
Teams who are competing in Remote style competition will need to follow field configuration below.



	High Junction
	Medium Junction
	Low Junction
	Ground Junction