

FIRST



FORWARD

PRESENTED BY **Qualcomm**



PRESENTED BY



Raytheon
Technologies

2021-2022 *FIRST*[®] Tech Challenge

Game Manual Part 2 – Traditional Events

Sponsor Thank You

Thank you to our generous sponsors for your continued support of the *FIRST*® Tech Challenge!

***FIRST*® TECH CHALLENGE
SEASON PRESENTING SPONSOR**



***FIRST*® TECH CHALLENGE
PROGRAM SPONSOR**



***FIRST*® TECH CHALLENGE
KEY SPONSOR**



Revision History		
Revision	Date	Description
1	9/7/2021	Program Delivery Partner Limited Release
1.1	9/18/2021	Kickoff Release

Contents

Contents	3
1.0 Introduction.....	4
What is <i>FIRST</i> ® Tech Challenge?	4
2.0 <i>Gracious Professionalism</i> ®.....	4
3.0 How to Use This Document	4
4.0 The Game	5
4.1 Introduction	5
4.2 Game Description	5
4.2.1 Game Narrative	5
4.2.2 Gameplay Overview	5
4.2.3 Gameplay Technology	6
4.3 Playing Field Illustrations.....	7
4.4 Game Definitions	8
4.5 Gameplay.....	14
4.5.1 Pre-Match.....	14
4.5.2 <i>Autonomous Period</i>	16
4.5.3 <i>Driver-Controlled Period</i>	17
4.5.4 <i>End Game</i>	17
4.5.5 Post Match	18
4.5.6 Penalties.....	18
4.5.7 Flowchart of Match Play	18
4.6 Rules of Gameplay.....	18
4.6.1 Safety Rules	18
4.6.2 General Game Rules	19
4.6.3 Game-Specific Rules	24
4.7 Scoring Summary.....	28
4.8 Rule Summary	29
Appendix A – Resources	35
Game Forum Q&A	35
Volunteer Forum	35
<i>FIRST</i> Tech Challenge Game Manuals.....	35
<i>FIRST</i> Headquarters Pre-Event Support	35

<i>FIRST</i> Websites.....	35
<i>FIRST</i> Tech Challenge Social Media	35
Feedback.....	35
Appendix B – Playing Field Details	36
Appendix C – Scoring Elements	41
Appendix D – Randomization	42
Appendix E – Scoring Examples.....	43
Appendix F – Navigation Images	46

1.0 Introduction

What is FIRST® Tech Challenge?

FIRST® Tech Challenge is a student-centered program that focuses on giving students a unique and stimulating experience. Each year, teams engage in a new game where they design, build, test, and program autonomous and driver operated robots that must perform a series of tasks. To learn more about *FIRST*® Tech Challenge and other *FIRST*® Programs, visit www.firstinspires.org.

2.0 Gracious Professionalism®

FIRST® uses this term to describe our programs’ intent.

Gracious Professionalism® is a way of doing things that encourages high-quality work, emphasizes the value of others, and respects individuals and the community.

Watch Dr. Woodie Flowers explain *Gracious Professionalism* in this [short video](#).

3.0 How to Use This Document

The Game Manual Part 2 – Traditional Events is a resource for all *FIRST*® Tech Challenge *Teams* for information specific to the 2021-2022 season’s game.

The intent of this manual is that the text means exactly, and only, what it says. Please avoid interpreting the text based on assumptions about intent, implementation of past rules, or how a situation might be in “real life”. There are no hidden requirements or restrictions. If you have read everything, you know everything.

Key words that have a specific meaning within this document are defined in the Game Definitions section and are indicated with the first letter capitalized, and the entire word in *Italics*.

4.0 The Game

4.1 Introduction

This document describes FREIGHT FRENZYSM presented by Raytheon Technologies, the FIRST® Tech Challenge game for the 2021-2022 season. We recommend viewing the game animation prior to reading this manual to gain a general understanding of the game. The animation is not intended as a replacement for official game rules. The animation can be accessed on our website under “Videos and Promotional Materials”: <https://www.firstinspires.org/resource-library/ftc/game-and-season-info>.

Teams must comply with all the rules and requirements stated in this document and in the Game Manual Part 1 - Traditional Events. Clarifications to the game rules are issued on the question & answer section of the forum at <https://ftc-qa.firstinspires.org>. Forum rulings take precedence over information in the game manuals.

Teams should refer to the [Game Manual Part 1 – Traditional Events](#) for information about the competition such as how rankings work (Ranking and TieBreaker Points), advancement, judged awards, *Robot* rules, and general competition rules.

4.2 Game Description

4.2.1 Game Narrative

The world of transport is undergoing some of the greatest changes of its time, all the while natural disasters, humanitarian crises, and food shortages are happening all around us. Of all the technological advances continuously inserted into our daily lives, which ones will help us transport hard to move goods and solve these global challenges?

Providing basic needs are necessary for cultivating a safe and more equitable world. But doing so can be quite complex. Our world depends on a strong transportation system to get essential items into the hands of those who need it most and move those in danger to safety. When our transportation networks improve with efficiency and scale, our people, our animals, and our livelihoods prevail.

The future of transporting relief to those in need is about inventing creative solutions, pushed by the recognition of the inefficiencies, inequities, and the choices we make around them.

Will we be able to work together and deliver a solution in the race against time? Only time will tell. A better, safer world is possible.

4.2.2 Gameplay Overview

Welcome to FREIGHT FRENZYSM presented by Raytheon Technologies. *Matches* are played on a *Playing Field* initially set up as illustrated in Figure 4.3-1. Two *Alliances* – one “red” and one “blue”, made up of two *Teams* each – compete in each *Match*. The object of the game is to attain a higher *Score* than the opposing *Alliance* by performing the achievements outlined below.

The *Match* starts with a 30-second *Autonomous Period* in which *Robots* operate using only pre-programmed instructions and sensor inputs. During the *Autonomous Period*, *Alliances* earn points by: *Delivering Pre-Loaded Boxes* to a randomly selected level of the *Alliance Shipping Hub*. *Teams* may opt to use the *Duck* placed on the field, or may use their *Team Shipping Element*, which provides more points when *Freight* is delivered to the correct level of the *Alliance Shipping Hub*. *Alliances* also earn points for *Navigating* to the *Storage Unit* or *Warehouse*, *Scoring Freight* in the *Storage Unit* or *Alliance Shipping Hub*, and *Delivering Ducks* onto the *Playing Field Floor* via the *Carousel*.

The two-minute *Driver-Controlled Period* follows the *Autonomous Period*. *Alliances* earn points by collecting *Freight* from the *Warehouse* and *Scoring the Freight* in the *Storage Unit*, their *Alliance Shipping Hub*, or the *Shared Shipping Hub*.

The final 30 seconds of the *Driver-Controlled Period* is called the *End Game*. In addition to the previously listed *Driver-Controlled Period Scoring* activities, *Alliances* may *Deliver Ducks* onto the *Playing Field*. If the *Team Shipping Element* was not introduced during *pre-Match* setup, *Alliances* may now *Deliver* their *Team Shipping Element*. The *Team Shipping Element* may be used to *Cap* their *Alliance Shipping Hub* to earn points. An *Alliance* will earn *Balance* points for the *Alliance Shipping Hub* being *Balanced*. If an *Alliance's* section of the *Shared Shipping Hub* is contacting the *Tile* floor, the *Alliance* will earn points.

4.2.3 Gameplay Technology

Each game comes with its own unique set of technology challenges. In FREIGHT FRENZY, there are multiple ways *Teams* can utilize technology to assist them in the challenge. *Teams* may use the built-in technology, or they can come up with their own solutions to solve the challenges.

This season, the challenges include:

1. Object Identification
 - a. The *Robot* can use its on-board control system to identify an object placed on one of the three *Barcode* locations. Correctly locating the object and then placing their *Pre-Loaded Box* onto the *Scoring Level* that corresponds to the *Barcode* location earns the *Team* bonus points.
 - b. *Teams* can use the built-in TensorFlow technology to identify the default object, a yellow *Duck*, but *Teams* that can train technologies like TensorFlow or use more traditional sensors to identify their *Team-built Team Shipping Element* will earn additional points.
2. Field Navigation
 - a. *Teams* can use the *Navigation Images* along with the built-in vision processing software, Vuforia, and an on-board camera to help identify their location on the field. This is especially useful during the *Autonomous Period*.
3. Sensor Use
 - a. *Teams* can add sensors to their *Robot* to help it identify the *Boxes*, as there are three different weighted *Boxes* located in the *Warehouse*.

For resources on how the available technologies please visit <https://github.com/FIRST-Tech-Challenge>.

4.3 Playing Field Illustrations

The following illustrations identify the *Game Elements* and give a general visual understanding of the game. *Teams* should refer to andymark.com/FTC for the exact *Game Element* dimensions. The official *Playing Field* documents, including the official Field Setup Guide, are available at <https://www.firstinspires.org/resource-library/ftc/game-and-season-info>. Please note: *Playing Field Wall* heights are different depending on the manufacturer. *Playing Field Wall* height measurements for each manufacturer are in the official Field Setup Guide. During the season, *Teams* may attend events that use *Playing Field Walls* from different manufacturers, please incorporate that into the design of your *Robot*.

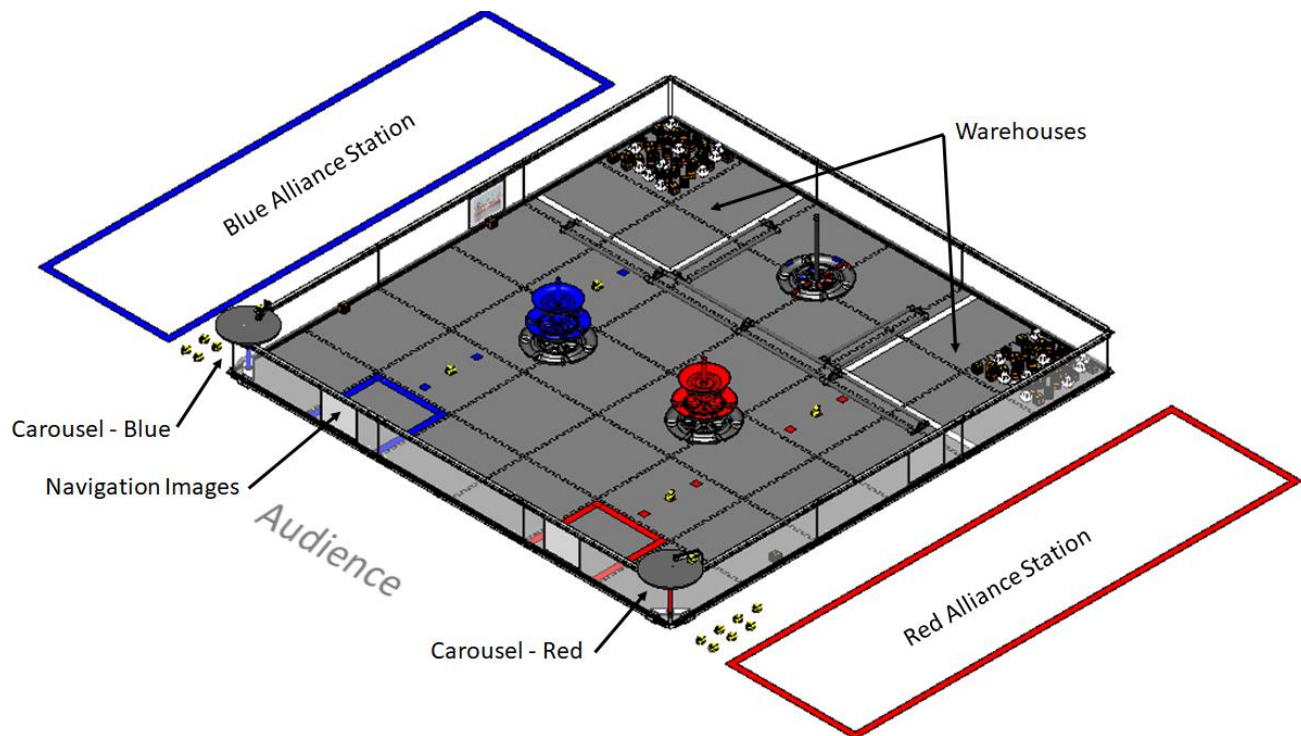

Figure 4.3-1 – Isometric view of the *Playing Field*

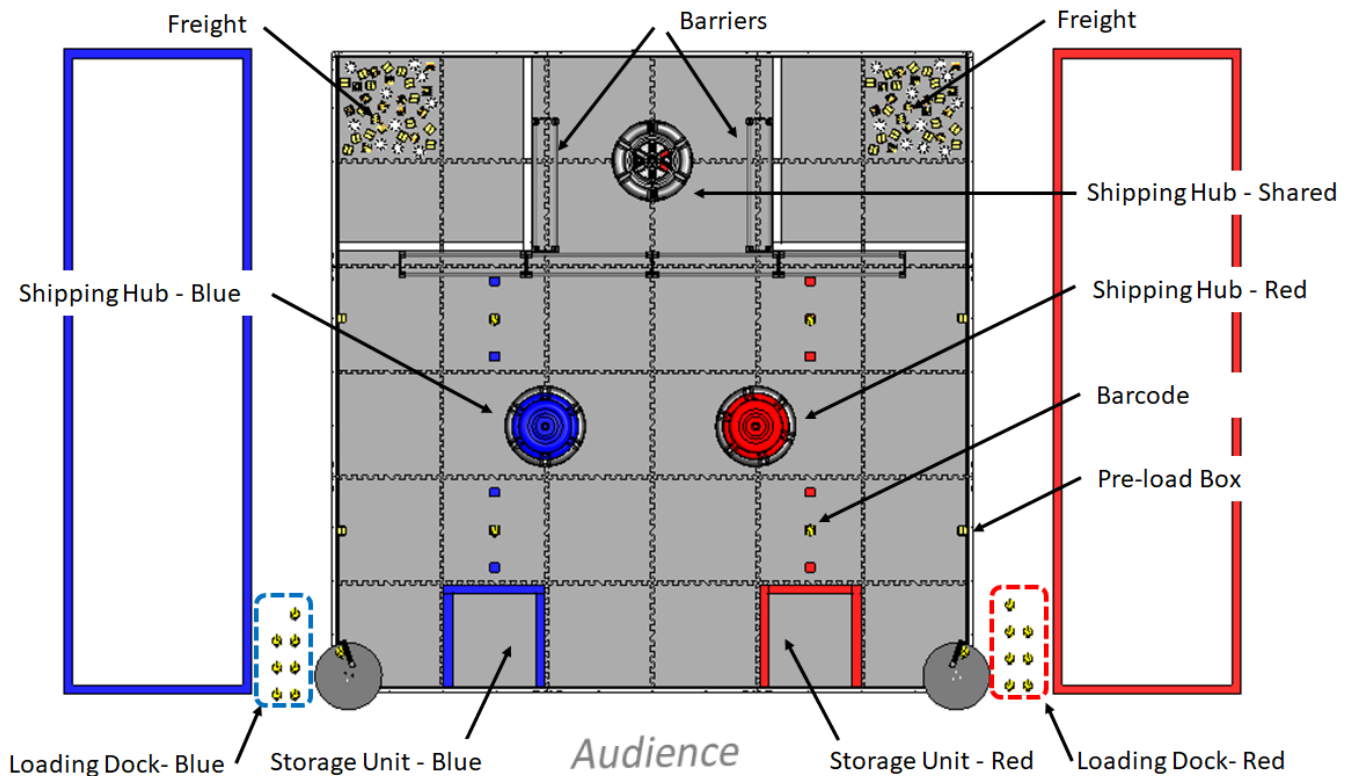

Figure 4.3-2 – Top view of the *Playing Field*

4.4 Game Definitions

The following definitions and terms are used for FREIGHT FRENZYSM. Game definitions are Capitalized and *italicized* throughout the manual.

Alliance – Each FIRST Tech Challenge *Match* consists of two, two-*Team Alliances*. The two *Teams* in one *Alliance* compete against the two *Teams* in the other *Alliance* to complete the game challenges and to earn the highest *Score*. For qualifying and championship tournaments with 21 or more *Teams*, the semi-final and final *Matches* *Alliances* consist of three *Teams* each. However, only two of those *Teams* compete during any one *Match*.

Alliance Neutral – Available to a *Robot* from any *Alliance*.

Alliance Specific – Benefits a *Robot* from a specific *Alliance* (i.e., red or blue *Alliance*).

Alliance Station – The designated “red” or “blue” *Alliance Area* adjacent to the *Playing Field* where the *Drivers* and *Coach* stand in during a *Match*.

Area – The space defined by the vertical projection of the outside edge of a region’s boundary (for example, gaffer tape, goal, *Playing Field Wall*). The boundary element (tape, wall, markings, etc.) is part of the *Area* for the purposes of determining *Inside* and *Outside*.

Autonomous Period – A thirty-second *Match* period in which the *Robots* operate and react only to sensor inputs and to commands pre-programmed by the *Team* onto the onboard *Robot* control system. Human control of the *Robot* is not permitted during this time.

Balanced / Unbalanced – A *Shipping Hub* is *Balanced* when it is *Completely Supported* by the *Playing Field Floor* and only the *Shipping Hub* domed base is touching the *Playing Field Floor*. All other states are *Unbalanced*.

Barcode – The four locations on the *Playing Field Floor* that consist of three taped squares each, where a *Duck* or *Team Shipping Element* is placed during pre-*Match* setup.

Barrier – Approximate 1-inch high by 5.5-inch wide (25.4 mm x 139.7 mm) obstacle on the *Playing Field*. *Barriers* do not belong to nor do they form the boundary of any defined *Area*.

Block / Blocking – Preventing an opposing *Alliance Robot* from accessing an *Area* or *Game Element* for an extended period by obstructing ALL paths of travel to the object or *Area*. Active defense played by a *Robot* shadowing an opposing *Alliance Robot* that eliminates all paths of travel between the opposing *Alliance Robot* and an *Area* or *Alliance Specific Game Element* or all remaining *Alliance Neutral Game Elements* is considered *Blocking*, even though at a given moment there is an open path. See also the definition of *Trap / Trapping*.

Cap / Capping – Placing a *Team Shipping Element* on top of the *Alliance Shipping Hub* pipe or on top of another legally *Scored Team Shipping Element*.

Carousel - The *Carousels* are located in the corners of the *Playing Field* adjacent to the *Alliance Stations*. There are two (2) *Carousels*, one (1) red and one (1) blue. *Carousels* are not self-powered and may only be rotated by *Robots* on the *Playing Field* in a manner described in Section 4.5. The following are components of the *Carousel*:

- a) **Platform** – A rotating portion of the *Carousel* used to *Deliver Ducks* and *Team Shipping Elements* into the *Playing Field*.
- b) **Rim** – The vertical surface at the perimeter of the *Platform* where *Robot* contact is allowed.
- c) **Sweeper Plate** – The stationary portion of the *Carousel* that causes the *Duck* or *Team Shipping Element* to fall from the *Platform* and into the *Playing Field*.

Coach – A student *Team* member or adult mentor designated as the *Drive Team* advisor during the *Match* and identified by wearing a “*Coach*” badge or identifying marker.

Competition Area – The *Area* where all the *Playing Fields*, *Alliance Stations*, scoring tables, on-deck queuing tables, event officials, and other competition items relating to *Match* play are located. The *Team Pit* area and practice *Playing Fields* are not part of the *Competition Area*.

Control / Controlling – An object is *Controlled* by a *Robot* if the object is following the movement of the *Robot*. Objects that are *Controlled* by a *Robot* are considered to be a part of the *Robot*. See also the definition of *Possess / Possessing*. Examples of interaction with *Game Elements* that are *Controlled* include, but are not limited to:

- a) Carrying one or more *Game Elements*.
- b) *Launched Game Elements* are considered *Controlled* until they make contact with something other than the *Playing Field Floor* or *come to rest*. See also the definition of *Launching* in this section.
- c) *Herding* of *Game Elements* is considered *Control*. See also the definition of *Herding* in this section.
- d) *Trapping* one or more *Scoring Elements* against a *Game Element*, *Playing Field Wall*, or *Robot* to shield or guard them. See also the definition of *Trapping* in this section.

Examples of interaction with *Game Elements* that are not *Controlled* include, but are not limited to:

- e) *Plowing of Game Elements* is not considered *Control*. See also the definition of *Plowing* in this section.
- f) *Inadvertent* contact with a *Launched Game Element* as it bounces off the *Playing Field* or a *Robot*. See also the definition of *Inadvertent* in this section.

Deliver / Delivered – The action of introducing a *Duck* or *Team Shipping Element* onto the *Playing Field*. A legal *Delivery* follows this sequence:

- a) *Drive Team* places a *Duck* or *Team Shipping Element* onto the *Carousel Platform Completely In the Drive Team* side of the *Sweeper Plate*. The *Duck* or *Team Shipping Element* must be in contact with the *Sweeper Plate*; then
- b) The *Robot* must rotate the *Carousel Platform*; then
- c) The *Sweeper Plate* must knock the *Duck* or *Team Shipping Element* off the *Carousel* onto the *Playing Field Floor*.

Disable / Disabled – A *Robot* that is no longer active for the remainder of the *Match* due to a *Robot* failure or by the request of a referee. Only a *Referee* can declare a *Robot Disabled*. If a referee *Disables* a *Robot* during a *Match*, they may ask the *Team* to drive their *Robot* to a neutral position on the *Playing Field*, issue a stop command with the *Driver Station*, and place their *Driver Station* in a hands-off location on a competition provided structure or the *Alliance Station* floor.

Disqualified / Disqualification / Disqualify – A *Team* that is ineligible to compete in a *Match*. A *Team* that is *Disqualified* from a *Match* will not receive credit for the *Match* (that is, no Ranking and no TieBreaker points).

Drive Team – Up to three (3) representatives; two (2) *Drivers* and one (1) *Coach* from the same *Team*.

Driver – A pre-college student *Team* member responsible for operating and controlling the *Robot* and identified by wearing a competition supplied *Driver* badge or identifying marker.

Driver-Controlled Period – The two-minute *Match* time period in which the *Drivers* operate the *Robots*.

Driver Station – Hardware and *FIRST* supplied software used by a *Drive Team* to control their *Robot* during a *Match*. A detailed description of the *Driver Station* rules is listed in [Game Manual Part 1 – Traditional Events](#).

End Game – The last thirty seconds of the two-minute *Driver-Controlled Period*.

End of the Period/Match - The moment when the *Match* timer reaches 2:00 for the *Autonomous Period* or 0:00 for the *Driver-Control Period* and which coincides with the start of the sound that designates the *End of the Period*.

Freight – *Freight* consists of *Cargo*, *Boxes*, and *Ducks*.

- a) **Cargo** – 2.75 inch (69.9 mm) diameter balls, weight: 1.18 oz. (33.5 grams). Quantity: Twenty (20)
- b) **Boxes** – 2 inch (50.8 mm) cubes. There are four (4) types of *Boxes*:
 - i. *Pre-Load* – 1.79 oz (50.5 grams). Quantity: Four (4)

- ii. Light – 1.79 oz (50.5 grams). Quantity: Twenty-Six (26)
 - iii. Medium – 3.28 oz (93.1 grams). Quantity: Twenty (20)
 - iv. Heavy - 4.78 oz. (135.4 grams). Quantity: Ten (10)
- c) **Ducks** – 2.125 inches x 2.0 inches x 2.0 inches (54.0 mm x 50.8 mm x 50.8 mm) rubber ducks, weight: 0.56 oz. (15.8 grams). Quantity: Twenty (20)

Game Element – Any item *Robots* interact with to play the game. *Game Elements* for this year's game include: *Barriers, Shipping Hubs, Carousels, Team Shipping Elements, and Freight.*

Herding – Pushing or moving one or more *Scoring Elements* to a desired location or direction that gains a strategic advantage beyond moving the *Robot* around the *Playing Field*. See also the definition of *Plowing* in this section.

In (Inside) / Completely In (Completely Inside) – An object that has crossed into the upwards vertical (for example, at a right angle to the *Playing Field Floor*) extension of a defined *Area's* boundary is *Inside* the *Area*. An object that is entirely within the upwards vertical extension of a defined *Area's* boundary is *Completely Inside* the *Area*. The boundary element (tape, wall, markings, etc.) is part of the *Area* for the purposes of determining *Inside* and *Outside*, unless otherwise specified.

Inadvertent – An unintended side effect of an allowed *Robot* action. Unforced or unexpected *Robot* actions based on software commands are not considered to be *Inadvertent*.

Inconsequential – An outcome that does not influence *Scoring* or gameplay.

Interference - Interaction between opposing *Alliance Robots* that amplifies the difficulty of a *Scoring* activity. Actions that constitute *Interference* should not be considered illegal except as specified by a game rule.

Launching – Propelling *Game Elements* with enough force such that they move independent of contact with the *Robot*. Movement solely due to gravity is not *Launching*.

Loading Dock – The unmarked *Area* outside the *Playing Field* located between the *Playing Field Wall* and the *Alliance Station*.

Match – A head-to-head competition between two *Alliances*. A *Match* consists of a thirty (30) second *Autonomous Period*, an eight (8) second transition and a two (2) minute *Driver-Controlled Period* for a total time of two minutes and thirty-eight seconds (2:38).

Navigating – An *Autonomous Period Scoring* task where a *Robot* is *Parked In* or *Completely In* a specified *Area*.

Navigation Image - Five (5) unique images mounted on the *Playing Field Walls* that *Robots* can use to navigate around the *Playing Field*. Images are printed on standard letter size paper, 8 1/2 inches x 11 inches (216 mm x 279 mm) or A4 (210 mm x 297 mm) paper. Images are mounted on the outside of the *Playing Field* as described in Appendix F.

Off / Completely Off – Not physically in contact with or *Supported* by an object, surface, etc. Objects that are *Off* are also considered *Completely Off*.

On / Completely On – An object that is physically in contact with and at least partially *Supported* by an object, surface, etc. is considered *On*. An object that is entirely *Supported* by an object, surface, etc. is *Completely On*.

Out / Outside – An object that does not extend into any part of a defined *Area* is *Outside* the *Area*.

Park / Parked – The condition where a *Robot* is motionless.

Penalty – The consequence imposed for a rule or procedure violation that is identified by a referee. When a *Penalty* occurs, points will be deducted from the *Score* of the *Alliance* that incurred the *Penalty*. *Penalties* are further defined into *Minor Penalties* and *Major Penalties*.

Penalties may also escalate to the issuing of a *Yellow Card* or *Red Card* as a result of a continued occurrence of a rule violation and upon discretion of the Referee.

Yellow Cards and Red Cards – In addition to rule violations explicitly listed in section 4.6, *Yellow Cards* and *Red Cards* are used in the *FIRST* Tech Challenge to manage *Team* and *Robot* behavior that does not align with the mission of *FIRST*. *Yellow* and *Red Cards* are not limited to just the *Competition Area*. *Teams* that display egregious behavior in the pit area, judging rooms, stands, or any other location of the competition can be issued a *Yellow* or *Red Card* for egregious behavior.

Illegal behaviors that are repeated (3 or more times), or egregious behaviors by a *Robot* or *Team* member at the competition can result in a *Yellow* and/or *Red Card*. *Yellow Cards* are additive, meaning that a second *Yellow Card* is automatically converted to a *Red Card*. A *Team* is issued a *Red Card* for any subsequent incident in which they receive an additional *Yellow Card*, for example, earning a second *Yellow Card* during a single *Match*.

Yellow and *Red Cards* may be issued on or off the competition field. For details, please make sure to read the Competition Rules outlined in section 3.5 of the [Game Manual Part 1](#) – Traditional Events.

Pin / Pinning – Preventing the movement around the *Playing Field* in all directions of an opposing *Alliance Robot* while it is in contact with the *Playing Field Wall*, one or more *Game Elements*, or another *Robot*.

Playing Field – The part of the *Competition Area* that includes the 12 ft. x 12 ft. (3.66 m x 3.66 m) field and all the *Game Elements* described in the official field documents. From the audience viewpoint, the *Red Alliance Station* is on the right side of the *Playing Field*.

Playing Field Damage – A physical change to a *Game Element* or *Playing Field* that affects gameplay.

Playing Field Floor – The top surface of the *Tiles* that make up the base of the *Playing Field*.

Playing Field Perimeter – The outside face of the *Playing Field Wall*.

Playing Field Wall – An approximate 12 inches (30.5 cm) tall, 12 ft. (3.66 m) long by 12 ft. (3.66 m) wide wall surrounding the *Playing Field Floor*. The height of the *Playing Field Wall* will vary depending on which *Playing Field Wall* is being used at the event. *Robots* should be built to interact with all legal *Playing Field Walls*.

Plowing – *Inadvertent* contact with *Game Elements* while in the path of the *Robot* moving about the *Playing Field* that provides no additional advantages beyond field mobility. See also the definition of *Herding* in this section.

Possess / Possessing – An object is in *Possession* by a *Robot* if, as the *Robot* moves or changes orientation (for example, moves forward, turns, backs up, spins in place), the object remains in approximately the same position relative to the *Robot*. Objects in *Possession* by a *Robot* are considered to be *Controlled*, and they are part of the *Robot*. See also *Control/Controlling*.

Pre-Load - A *Game Element* that a *Drive Team* positions during pre-*Match* setup so that it touches a *Robot* or is *Possessed* by a *Robot* at the start of the *Autonomous Period*.

Queuing Area – The location in the *Competition Area* where *Drive Teams*, *Robots*, and optional *Robot carts* are staged until directed by competition personnel to set up their *Robots* on a *Competition Playing Field*.

Robot – Any mechanism that has passed *Robot* inspection and a *Drive Team* places on the *Playing Field* prior to the start of a *Match*. A detailed definition of *Robot* is in the *Robot* rules section in the [Game Manual Part 1 – Traditional Events](#).

Score / Scoring – *Robots* earn points for their *Alliance* by interacting with *Scoring Elements* and *Navigating* to specific *Areas* of the *Playing Field*. *Scoring Elements* that are still in contact with *Robots* of the corresponding *Alliance* have zero (0) *Score* value, unless otherwise specified in Sections 4.5 or 4.6.

Scoring determination is done by one of three methods: “*Scored Live*”, “*Scored at End of the Period*”, and “*Scored at Rest*.” The specific method for each *Scoring* achievement will be stated in the achievement’s description in Section 4.5.

- a) **Scored Live:** The achievement is considered *Scored* the moment it is successfully completed, i.e., all criteria are met.
- b) **Scored at End of the Period:** The achievement’s *Scoring* status is determined based on the *Robot* or *Scoring Element*’s position at the *End of the Period*.
- c) **Scored at Rest:** The achievement is considered *Scored* based on the position of the *Robot* or *Scoring Element* when the entire field has come to rest after the *Match Period* ends.

Scoring Elements – Objects that *Robots* manipulate to earn points for their *Alliance*. The *Scoring Elements* for FREIGHT FRENZY are *Freight* and *Team Shipping Elements*.

Shipping Hubs –

- a) **Alliance Shipping Hub** - An *Alliance Specific Game Element* with three (3) *Levels*. There are two (2) *Alliance Shipping Hubs*, one (1) red and one (1) blue. The three (3) *Levels* are as follows (all dimensions are approximate):
 - i. **Level 1:** 18 inches (457 mm) diameter and 3 inches (76.2 mm) above the *Playing Field Floor*.
 - ii. **Level 2:** 15 inches (381 mm) diameter and 8.5 inches (215.9 mm) above the *Playing Field Floor*.
 - iii. **Level 3:** 12 inches (305 mm) diameter and 14.75 inches (374.6 mm) above the *Playing Field Floor*.
- b) **Shared Shipping Hub** – An approximate 18-inch (45.7 cm) diameter *Game Element* where *Robots* from both *Alliances* place *Freight*. The *Shared Shipping Hub* is divided into two semi-circular *Alliance Specific Areas*.

Storage Unit – An approximate 22.75-inch by 22.75-inch (57.8 cm x 57.8 cm) *Alliance Specific Scoring Area* where *Robots* can place *Freight*. The *Storage Unit* is located toward the audience side of the *Playing Field*.

Support / Supported / Completely Supported – An object (i.e., *Robot*, *Scoring Element*, *Game Element*, etc.) is *Supported* by another object if the second object is bearing at least some of the weight of the first object. If the second object is bearing all the weight of the first object, it is *Completely Supported* by the second object.

Team – Mentors, supporters, and pre-college-aged students affiliated with an entity registered with *FIRST* and for the competition.

Team Shipping Element – The *Team Scoring Element* for this season. A *Team* designed and manufactured part that may be used in the *Match*. A detailed definition of *Team Shipping Element* is in section 7.4 of the Game Manual Part 1. Compliance with construction rules will be verified during *Robot Inspection*.

Tile – An approximate 24-inch x 24-inch (610 mm x 610 mm) foam rubber mat. The *Playing Field Floor* has thirty-six (36) *Tiles*.

Trap / Trapping – Preventing an opposing *Alliance Robot* from escaping a constrained *Area* of the *Playing Field* for an extended period of time by obstructing all paths of travel from the object or *Area*. See also the definition of *Block / Blocking* in this section.

Warehouse – An approximate 43.5-inch x 43.5-inch (110.5 cm x 110.5 cm) *Area* of the *Playing Field* that is bounded on two sides by white tape and two sides by the *Playing Field Wall*. There are two (2) *Alliance Neutral Warehouses* located on the *Field*.

Warehouse Operations - A *Robot* must perform the following sequence to remove a piece of *Freight* from the *Warehouse*:

- a) Start *Completely Out* of the *Warehouse*, then
- b) Drive *Completely In* the *Warehouse*, then
- c) Collect one (1) piece of *Freight*, then
- d) Drive *Completely Out* of the *Warehouse* with the collected *Freight*.

Warning - *Warnings* apply to the entire *Team*. *Warnings* have no effect on an *Alliance's Score*. Individual actions of a single *Team* member will count as a *Warning* for the entire *Team*.

4.5 Gameplay

Prior to the start of the *Match*, *Drive Teams* perform some basic *Robot* setup steps that are described in section 4.5.1. *Matches* are made up of several periods totaling two minutes and thirty seconds (2:30). There is a thirty (30) second *Autonomous Period*, followed by a two (2) minute *Driver-Controlled Period*. The last thirty (30) seconds of the *Driver-Controlled Period* is called the *End Game*. When the *Match* is over and referees signal, *Drive Teams* collect their *Robots*, return *Possessed Game Elements* to the *Playing Field*, and exit the *Competition Area*.

4.5.1 Pre-Match

- 1) Field personnel set up the *Playing Field* as depicted in Figure 4.3-1.
 - a) One (1) *Pre-Load Box* is placed at each *Robot* starting location for *Pre-Loading* by the *Drive Teams*.
 - b) Approximately half of the remaining *Freight* (*Cargo*, *Light Box*, *Medium Box*, *Heavy Box*) are placed in *each Warehouse* as described in Appendix B.
 - c) *Shipping Hubs* are placed at their starting locations.
 - d) Ten (10) *Ducks* per *Alliance* are placed as follows:

- i. One (1) *Duck* is placed on each *Carousel* in contact with the outer vertical surface of the *Sweeper Plate*. See Appendix B-5 for position and orientation.
- ii. One (1) *Duck* is placed on each center *Barcode*. See Appendix D for position and orientation.
- iii. The remaining *Ducks* are placed *In* the *Alliance Loading Dock*.

2) *Drive Teams* set up their *Robots* on the *Playing Field* with the following constraints:

a) **Starting Location**

- i. *Drive Teams*, with agreement of their *Alliance Partner*, select their *Robot's* starting location.
- ii. *Robots* and their *Pre-Load Box* must be placed *Completely Inside* the *Playing Field Perimeter*.
- iii. *Drive Teams* must place their *Robots*, in any orientation, touching the *Playing Field Wall* adjacent to their *Alliance Station*.
- iv. *Robots* cannot start in the *Warehouse*, in contact with a *Carousel*, or *On* a *Barrier*.

b) **Pre-Loaded Freight** – A *Robot* must *Pre-Load* exactly one (1) *Pre-Load Box*.

c) **Team Shipping Element** – *Drive Teams* intending to use their *Team Shipping Element* have two options:

- i. *Team Shipping Elements* may be placed in the *Alliance's Loading Dock*, or
- ii. A *Team Shipping Element* may be placed on their corresponding center *Barcode* with the *Duck* moved to the *Alliance's Loading Dock*.

d) **Op Mode** – *Drive Teams* use their *Driver Station* Android device to:

- i. Select an *Autonomous Op Mode*. If the *Team* does not have an *Autonomous Op mode*, these steps can be skipped.
- ii. The thirty-second timer must remain enabled.
- iii. Press the *Driver Station* "Init" button.
- iv. *Drive Teams* may not touch their *Driver Stations* or controllers until the *Autonomous Period* has ended, except to start their *Autonomous* program with a single touch to the *Driver Station* Android device screen using the built-in thirty-second timer.

3) Once the referees signal that set-up is complete:

- a) *Drive Teams* may no longer touch their *Robots* until the conclusion of the *Match*.
- b) *Drive Teams* may not touch their *Driver Stations* or controllers until the *Autonomous Period* has ended. Exceptions to this include using the *Driver Station* to start their *Autonomous* program or to *Disable* their *Robot* as instructed by a referee.
- c) After the referee's signal that set-up is complete, field personnel will randomize the field into one of three (3) configurations as chosen by the scoring system or a dice throw as shown in

Appendix D. Field Personnel will attempt to maintain the orientation of the *Team Shipping Element* as it was placed on the field by the *Drive Team*.

4.5.2 Autonomous Period

The *Match* starts with a thirty (30) second *Autonomous Period* where *Robots* are operated only via pre-programmed instructions. *Teams* are not allowed to control *Robot* behavior with the *Driver Station* or any other actions during the *Autonomous Period*. The *Driver Station* is placed in a hands-off location during the *Autonomous Period* so that it is evident that there is no human control of *Robots*. The only exception is to allow *Drive Teams* to start their *Robot* with a “start” command issued on the *Driver Station* touch screen. *Teams* must use the built-in thirty-second timer.

Following a countdown by field personnel, the *Autonomous Period* begins. *Drive Teams* may issue a *Robot* start command with their *Driver Station* Android device to run the *Autonomous Op Mode* that was initialized during *Pre-Match* setup. Failure to adhere to this procedure may subject the *Team* to a *Penalty* as specified in the game rules in section 4.6.2. *Drive Teams* are not required to start executing an *Op Mode* during the *Autonomous Period*.

During the *Autonomous Period*, *Drive Teams* may not place *Ducks* or *Team Shipping Elements* On the *Carousel*.

Autonomous points are *Scored at Rest* for the following achievements:

- 1) **Carousel** – *Delivering* the preplaced *Duck* from the *Carousel* earns ten (10) points.
- 2) **Navigating** –
 - a) *Robots Parked In* their *Alliance’s Storage Unit* earn three (3) points.
 - b) *Robots Parked Completely In* their *Alliance’s Storage Unit* earn six (6) points.
 - c) *Robots Parked In* the *Warehouse* closest to the *Robot’s* corresponding *Alliance Station* earn five (5) points.
 - d) *Robots Parked Completely In* the *Warehouse* closest to the *Robot’s* corresponding *Alliance Station* earn ten (10) points.
- 3) **Freight** – *Robots* placing *Freight* earn points as follows:
 - a) *Each piece of Freight* positioned *Completely In* the *Alliance Specific Storage Unit* earns two (2) points.
 - b) *Each piece of Freight* placed *Completely On* an *Alliance Shipping Hub*, regardless of *Level*, earns six (6) points.
- 4) **Autonomous Bonus** – *A Robot* will earn points for placing its own *Pre-Loaded Box* on the *Alliance Shipping Hub* level (#1, #2, #3) that corresponds to the randomly selected *Barcode* location (#1, #2, #3). *A Robot* may earn only one (1) bonus for correctly placing its own *Pre-Loaded Box*.
 - a) *A Robot* that uses the pre-placed *Duck* to detect the correct *Level* earns ten (10) points.
 - b) *A Robot* that uses the *Team Shipping Element* to detect the correct *Level* earns twenty (20) points.

4.5.3 Driver-Controlled Period

Directly following the end of the *Autonomous Period*, *Drive Teams* have five (5) seconds plus a "3-2-1-go" countdown to prepare their *Driver Stations* for the start of the 120 second *Driver-Controlled Period*. On the countdown word "go," the *Driver-Controlled Period* starts, and *Drive Teams* press their *Driver Station* start button to resume playing the *Match*.

During the *Driver-Controlled Period*, *Carousels* may not be rotated until the *End Game*.

Driver-Controlled tasks are *Scored at Rest*:

- 1) **Freight** – Each piece of *Freight* that is *Scored* earns points for the *Alliance* designated by that *Area*. For example, *Freight* placed by a red *Alliance Robot Completely On* the blue *Alliance* portion of the *Shared Shipping Hub* *Scores* points for the blue *Alliance*.
 - a) Each piece of *Freight Scored Completely In* the *Alliance Specific Storage Unit* earns one (1) point.
 - b) Each piece of *Freight Scored* in the *Alliance Shipping Hub* earns two (2) points for being *Completely On* level #1, four (4) points for being *Completely On* level #2, and six (6) points for being *Completely On* level #3.
 - c) Each *Freight Scored Completely On* the *Shared Shipping Hub* earns four (4) points for the *Alliance* that corresponds to that side of the *Hub*. *Freight In* two *Alliance Specific Areas* has zero *Score* value.

4.5.4 End Game

The last thirty seconds of the *Driver-Controlled Period* is called the *End Game*. *Driver-Controlled Period Scoring* can still take place during the *End Game*. *End Game* tasks, with the exception of *Parking* and the *Balance* position of the *Shipping Hubs*, started prior to the start of the *End Game* will earn zero (0) points for those tasks.

End Game tasks are *Scored at Rest*.

- 1) **Duck and Team Shipping Element Delivery** – Each *Duck* or *Team Shipping Element Delivered* to the *Playing Field Floor* earns six (6) points.
- 2) **Shipping Hub Status** –
 - a) If an *Alliance's Shipping Hub* is *Balanced*, the *Alliance* receives ten (10) points.
 - b) If an *Alliance's* section of the *Shared Shipping Hub* is contacting the *Tile Floor* (i.e., the *Shared Shipping Hub* is *Unbalanced* in favor of that *Alliance*), the *Alliance* receives twenty (20) points (See Appendix E for *Scoring* examples).
- 3) **Parking** –
 - a) *Robots Parked In* a *Warehouse* earn three (3) points.
 - b) *Robots Parked Completely In* a *Warehouse* earn six (6) points.
- 4) **Capping** – For each *Team Shipping Element* that is fully *Supported* by the center pole above *Level #3* of their *Alliance Shipping Hub* or by another *Capped Team Shipping Element*, an *Alliance* earns fifteen (15) points.

4.5.5 Post Match

After the *Match*, field personnel will finalize the *Score*. Referees will signal for the *Drive Teams* to enter the *Playing Field* and retrieve their *Robots* and *Team Shipping Elements*. *Drive Teams* should return any *Game Elements* that are *Possessed* by the *Robot* to the *Playing Field*. The *Playing Field* reset crew will set up the *Playing Field* for the next *Match*.

4.5.6 Penalties

Penalty points are subtracted from the offending *Alliance's Score* at the *End of the Match*. *Minor Penalties* subtract ten (10) points per occurrence. *Major Penalties* subtract thirty (30) points per occurrence. *Warnings* have no effect on an *Alliance's Score*.

4.5.7 Flowchart of Match Play

The following figure shows the typical flow of the *Match* and the actions taken on the *Driver's Station* Android device.

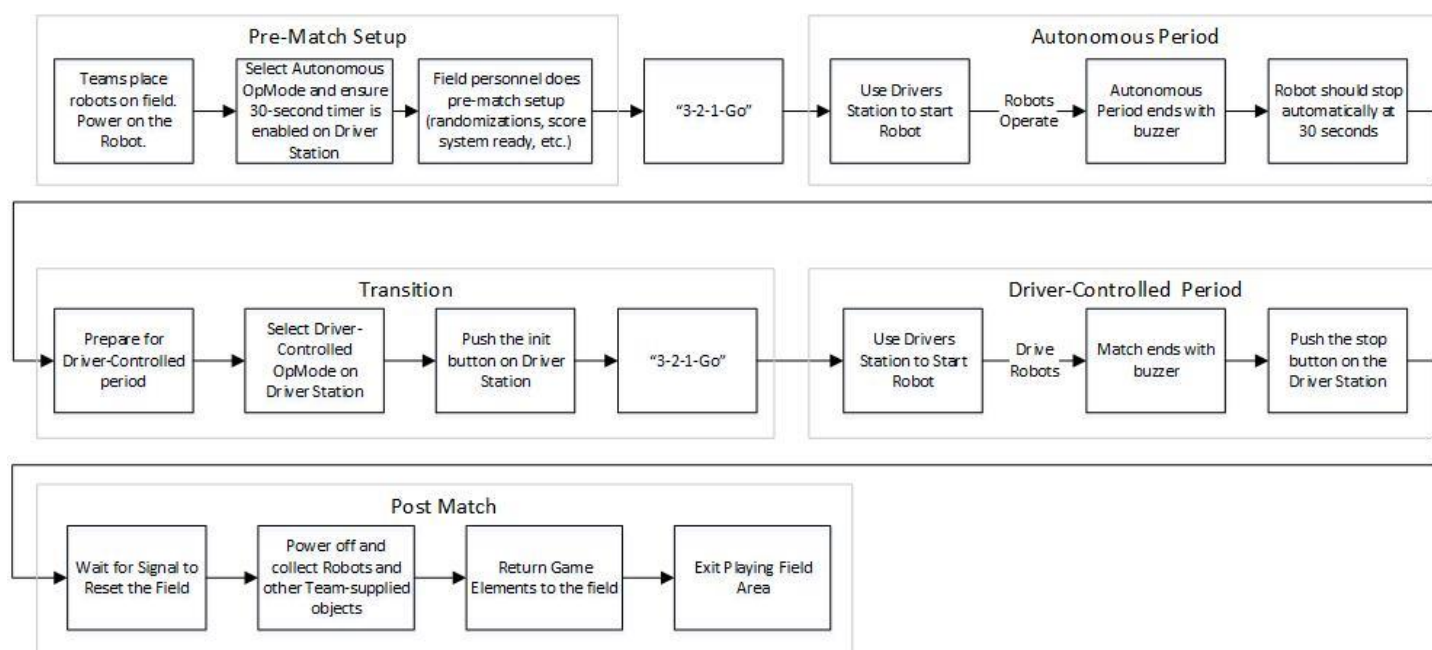

4.6 Rules of Gameplay

Gameplay is restricted by the Safety rules (<S#>), the General rules (<G#>), and the Game-Specific rules (<GS#>). Other rules to pay close attention to are the *Robot* rules, the inspection rules, and the competition rules defined in the [Game Manual Part 1 – Traditional Events](#). Violation of rules may lead to *Penalties*, *Yellow Cards*, *Red Cards*, a *Disabled Robot*, or *Disqualification* of the offending *Team* or *Alliance* from either a *Match* or the competition. Rules apply to all periods of play unless otherwise specified. If rules are in conflict, Safety rules take precedence over all rules and Game-Specific rules take precedence over General rules. **The official FIRST Tech Challenge Question & Answer Forum rulings take precedence over all information in the game manuals.**

4.6.1 Safety Rules

<S1> **Unsafe Robot or Playing Field Damage** – If at any time the *Robot* operation is deemed unsafe or has damaged the *Playing Field* or another *Robot*, by the determination of the referees, the offending *Robot* may be *Disabled*, and the *Team* may be issued a *Yellow Card*. Re-inspection of the *Robot* is required before it may play another *Match*. Damage that requires significant repair and/or delays subsequent *Match* play is likely to escalate to a *Red Card*.

<S2> Robot Extension Outside the Playing Field Perimeter – If any portion of the *Robot* contacts anything *Outside* the *Playing Field Perimeter*, the *Team* will be issued a *Yellow Card* and it may be *Disabled* immediately for the remainder of the *Match*, unless allowed by Game-Specific rule(s) listed in section 4.6.3. See the game definitions in section 4.4 for a complete description of the *Playing Field Perimeter*.

The intent of this rule is not to *Penalize* an *Alliance* for *Inadvertent*, safe *Robot* extension *Outside* the *Playing Field Perimeter*. Intentional *Robot* extension *Outside* the *Playing Field* is not permitted.

<S3> Safety Gear – All members of the *Drive Team* are required to wear approved eye protection and shoes with closed toed and a closed back. If any member of the *Drive Team* is not wearing these safety items, the referee will issue a *Warning* to the *Team* member(s) and if the situation is not remedied within thirty (30) seconds, the offending member(s) of the *Drive Team* must leave the *Competition Area* for the remainder of the *Match* and may not be replaced by another *Team* member. Failure to comply with a request to leave the *Competition Area* violates rule <G30>. Repeated *Team* member violations during the competition will escalate to a *Team Warning*. Following the *Team Warning*, subsequent violations by any member of the *Team* will result in a *Minor Penalty* for the *Alliance*.

4.6.2 General Game Rules

<G1> Autonomous to Driver-Controlled Period Transition – At the conclusion of the *Autonomous Period*, *Robots* will remain in a hands-off state. Field personnel will not enter the field and will not touch *Robots* on the field during the *Autonomous* to *Driver-Controlled* transition. The scoring system display will provide visual and audio cues for *Drive Teams* to pick up their *Driver Stations*. *Drive Teams* will have five (5) seconds to pick up and prepare their *Driver Station*. After five (5) seconds, there will be a “3-2-1 go” countdown and the *Driver-Controlled Period* of the *Match* will begin.

<G2> Score Certification at the End of the Match – Scores will be tracked by field personnel throughout the *Autonomous* and *Driver-Controlled Periods* of the *Match*. At the *End of the Match*, the final *Score* will be certified as quickly as possible. A change in state of a *Game Element* or *Robot* at the *End of the Match* after its final *Score* is recorded will not change an already-recorded *Score*. *Scoring Elements* will not be recounted after the *End of the Match* unless otherwise specified by a Game-Specific rule.

<G3> Forcing an Opponent to Break a Rule – The actions of an *Alliance* or their *Robots* shall not cause an opposing *Alliance* or *Robot* to break a rule and thus incur *Penalties*. Any forced rule violations committed by the affected *Alliance* shall be excused, and no *Penalties* will be assigned to the affected *Alliance*.

<G4> Robot Manipulation of Scoring Elements – *Scoring Elements* that are *Controlled* or *Possessed* by a *Robot* are part of the *Robot* except when determining the location of the *Robot* or otherwise specified by a Game-Specific rule.

For Example: If a *Robot* Possesses a *Scoring Element*, and only that *Scoring Element* breaks the plane of a *Scoring Area*, the *Robot* does not receive points for being *In* that *Area*.

<G5> Robot or Scoring Elements In Two or More Scoring Areas – *Robots* or *Scoring Elements* that are *In* two or more *Scoring Areas* earn points only for the highest value achievement. If the achievement values are equal, only one achievement counts as *Scored*.

<G6> Scoring Elements in Contact with Robots – *Scoring Elements* in a *Scoring Area* that are in contact with or *Controlled* by a *Robot* on the corresponding *Alliance* for the *Scoring Area* have zero *Score* value.

<G7> Disabled Robot Eligibility - If a referee *Disables* a *Robot*, it will not be eligible to *Score* or earn points for the remainder of the *Match*. A *Disabled Robot* (whether referee induced or failure) does not earn *Penalties* after becoming *Disabled*.

<G8> Playing Field Tolerances – Competition provided *Playing Field* and *Game Elements* will start each *Match* with tolerances that may vary by as much as +/-1.0 inch (25.4 mm). *Teams* must design their *Robots* accordingly.

Playing Field and *Game Elements* are expected to be manufactured, assembled, and set up using a high standard for dimensional and location accuracy. The intent of the generous +/- 1.0 inch tolerance is to accommodate unintentional size and location variations that may occur. The tolerance is not an excuse for intentional or imprecise accuracy in construction or setup.

<G9> Match Replay – *Matches* are replayed at the discretion of the Head Referee only for a failure of a non-*Team* supplied *Game* or *Field Element* or verified Wi-Fi interference that was likely to have impacted which *Alliance* won the *Match*.

Unexpected *Robot* behavior will not result in a *Match* replay. *Team*-induced failures, such as low battery conditions, processor sleep time-outs, *Robot* mechanical, electrical, software, or communication failures, etc. are NOT valid justifications for a replaying of a *Match*.

<G10> Inadvertent and Inconsequential - *Robot* actions that violate a rule may be ruled at the referee's discretion to be *Inconsequential* and *Inadvertent* and will not be *Penalized*.

<G11> Illegal Match Communication – Electronic communication (cell phone, two-way radio, Wi-Fi, Bluetooth, etc.) by *Drive Team* members after an *Alliance* has been called from the queue to the *Playing Field* for its *Match* is not allowed. The first instance of violating this rule will result in a *Warning*, with any following instances during the competition resulting in a *Minor Penalty*. Items that may be mistaken by a casual observer as being in violation of this rule should not be brought to the *Playing Field*. The *Driver Station* is exempt from this rule but must be used only for operating the *Robot*.

<G12> Playing Field Access - *Team* members must not enter the *Playing Field* for any reason other than to place/retrieve their *Robots*. While placing *Robots*, *Teams* may not measure, test, or adjust *Game Elements* unless allowed by Section 4.5.1. When retrieving *Robots*, *Teams* may not verify the *Scoring of Game Elements*.

The consequences for violating this rule are:

- a) *Minor Penalty* for violations during *Match* setup or following the *End of the Match*.
- b) *Major Penalty* for violations that delay the start of the *Match*.
- c) Violations of this rule outside of normal *Match* play will result in a *Yellow Card*.

If a *Team* feels the *Playing Field* is not set up correctly, *Teams* should notify a referee or field technical advisor prior to the start of the *Match*.

<G13> Pre-Match Robot Placement – At the beginning of a *Match*, each *Alliance Robot* must be set up on the *Playing Field* according to section 4.5.1 *Pre-Match*. After *Robots* are set up on the *Playing Field*, *Drive Teams* must stand *Inside* their respective *Alliance Station*.

- a) During the Qualification *Matches*, the blue *Alliance Robots* are set up on the *Playing Field* first, unless the red *Alliance* waives their right to set up on the *Playing Field* second.
- b) During the Elimination *Matches*, the 3rd and 4th seeded *Alliance Robots* are set up on the *Playing Field* first, unless the higher seeded *Alliance* waives their right to set up on the *Playing Field* second. *Alliance* color doesn't change the seeding of a *Team* during the Elimination *Matches*. If the 4th seed defeats the 1st seed in the Semi-Finals, they will still have to place their *Robot* on the field first in the finals because their seeding will be lower than the 2nd or 3rd seed.
- c) During Elimination *Matches*, three *Team Alliances* may only place two *Robots* that are intended to compete in that *Match*. After the *Robots* are placed, the *Alliance* cannot swap in the 3rd *Alliance's Robot* for a *Robot* already placed.
- d) *Teams* may implicitly waive their right to place their *Robots* on the *Playing Field* last by placing their *Robots* on the *Playing Field* before or with the opposing *Alliance*. There is no need to tell the referees; *Teams* waive their right by the act of placing their *Robots* on the *Playing Field*.
- e) *Teams* that unnecessarily delay the beginning of a *Match* and/or field reset will incur a *Minor Penalty* for each offense. Significant delays may escalate to a *Major Penalty* at the discretion of the head referee.

Drive Teams are expected to stage their *Robots* for a *Match*, and remove it from the *Playing Field* afterwards, safely and swiftly. *Drive Team* efforts that either intentionally or unintentionally delay the start of a *Match* or the *Playing Field* reset are not allowed. Examples include, but are not limited to:

- Late arrival to the *Playing Field*.
- *Robot* maintenance once on the *Playing Field*.

If the field is waiting for the *Team*, they would be subject to this *Penalty*.

<G14> Robot Starting Volume – Before the start of a *Match*, each *Robot* in its starting location must not exceed a volume of 18 inches (457.2 mm) by 18 inches (457.2 mm) by 18 inches (457.2 mm). A *Pre-Loaded Scoring Element* may extend *Outside* the 18-inch (457.2 mm) cube volume constraint. Once a violation has been identified, if the *Team* cannot fix the violation within thirty (30) seconds, the offending *Robot* will be removed from the *Playing Field*. *Robots* removed from the field are not subject to a delay of game (<G13>e) *Penalty*. The *Team* remains eligible to earn *Ranking* and *TieBreaker Points* if a member of the *Drive Team* is in their *Alliance Station* during the *Match*.

After the start of a *Match*, the *Robot* may extend in any direction unless otherwise specified by the Game-Specific rules detailed in section 4.6.3.

<G15> Robot Setup Alignment – *Teams* may align their *Robots* during Pre-*Match* setup if they do so with legal components that are part of the *Robot* and can be reset to be within the 18-inch (457.2 mm) cube starting volume constraint. A single member of the *Drive Team* may also align the *Robot* by sight if they are next to the *Robot* and their action does not delay the start of a *Match*. A *Minor Penalty* will be assessed to the *Alliance* for violation of this rule.

<G16> Alliance Stations – During a *Match*, the *Drivers* and *Coaches* must remain *In* their *Stations*.

- a) *Drive Teams* may be anywhere in their respective *Alliance Station*.

- b) The first instance of leaving the *Station* will result in a *Warning*, with any following instances during the *Match* resulting in a *Minor Penalty*. Leaving the *Station* for safety reasons will not result in a *Warning* or *Penalty*
- c) Opposing *Alliance's Drive Team* members cannot distract and/or interfere with each other nor the off-field *Scoring Elements*. Violation of this rule will result in an immediate *Major Penalty* and a possible *Yellow Card*.

The intent of this rule is to prevent *Drive Team* members from leaving their assigned *Station* during a *Match* to gain a competitive advantage. For example, moving to another part of the *Field* for better viewing, reaching into the *Field*, etc. Simply breaking the plane of the *Station* during normal *Match* play is not a *Penalty*.

<G17> Post-Match Removal of Robots – *Robots* must be designed to permit easy removal of *Game Elements* from the *Robot* after the *Match*. *Robots* should also be able to be removed from the *Playing Field* without unnecessary delay or damaging the *Playing Field*. A *Minor Penalty* will be assessed for violations of this rule.

The intent of this rule is to have timely removal of *Robots* from the *Playing Field* following a *Match*. *Drive Teams* are expected to stage their *Robots* for a *Match*, and remove them from the *Playing Field* afterwards, safely, and swiftly. *Drive Team* efforts that either intentionally or unintentionally delay the start of a *Match* or the *Playing Field* reset are not allowed. Examples include, but are not limited to:

- 1) Failing to exit the *Playing Field* once instructed by a referee.
- 2) Failing to remove *Driver Stations* in a timely manner.

<G18> Starting Gameplay Early – *Robots* that start playing the game (*Autonomous* or *Driver-Controlled Period*) prior to the start of a *Match Period* receive a *Minor Penalty*. Referees have the option of issuing a *Major Penalty* in place of the *Minor Penalty* if the early start results in a competitive advantage for the offending *Alliance*.

<G19> Late Start of the *Autonomous Period* – A *Drive Team* that starts their *Robot's Autonomous Op Mode* late will receive a *Minor Penalty*. Referees have the option of issuing a *Major Penalty* in place of the *Minor Penalty* if the late start results in a competitive advantage for the offending *Alliance*.

<G20> Robot Actions at End of the Period –

- a) *Robots* must *Park* at the *End of the Autonomous* and *Driver-Controlled Periods*. *Robots* that are not *Parked* at the conclusion of the “game sound” receive a *Minor Penalty* and the actions of the *Robot* do not count towards their *Alliance's Score*. *Drive Teams* should make their best effort to stop gameplay immediately when the *End of the Period* game sound begins. Referees have the option of issuing a *Major Penalty* in place of the *Minor Penalty* if the late stop results in a competitive advantage (other than *Scoring*) for the offending *Alliance*.
- b) *Scoring* achievements that were started (unless disallowed by Game-Specific rules) before the *End of the Period* are eligible to be counted as *Scored*.

- c) *Robot Scoring* achievements that occur after the announced *End of the Autonomous Period* and before the start of the *Driver-Controlled Period* do not count towards the *Score* for the *Autonomous* or *Driver-Controlled Periods*.

<G21> Robot Control During Autonomous Period - During the *Autonomous Period*, *Drive Teams* may not directly or indirectly control or interact with *Robots* or *Driver Stations*. Early stopping of the *Robot* while running its *Autonomous* code is not allowed, except in cases of personal or equipment safety, and any achievements earned due to early stoppage will not *Score* points. A *Major Penalty* will be assessed for violating this rule. *Teams* that stop their *Robots* during the *Autonomous Period* are allowed to participate in the *Driver-Controlled Period* provided it can be done safely.

<G22> Drive Team Contact with the Playing Field or Robot – During a *Match*, the *Drive Team* is prohibited from making contact with the *Playing Field*, any *Robot*, or any *Game Element* unless allowed by Game-Specific rules. The first instance of contact will result in a *Warning*, with any following instances during the competition resulting in a *Minor Penalty*. Contact that affects *Scoring* and/or gameplay will result in issuance of a *Yellow Card* at the discretion of the referees. Contact with the *Playing Field*, a *Game Element*, or a *Robot* for safety reasons will not result in a *Warning* or *Penalty*.

For example, a *Game Element* is *Launched* from a *Robot* on the *Playing Field* and it *Inadvertently* hits a *Team* member in the *Alliance Station* and is deflected back onto the field. The *Team* would not receive a *<G22> Penalty* because the *Team* member was protecting themselves (safety). However, if that same *Game Element* is caught and/or directed to a specific location on the *Playing Field*, the *Team* may be issued a *<G22> Penalty*.

<G23> Drive Team Coach Driver Station Control – During the *Driver-Controlled Period*, *Robots* must be remotely operated only by the *Drivers* using the Gamepads connected to the *Team's Driver Station* and/or by software running on the on-board *Robot* control system. The first instance of *Coach* operating a Gamepad will result in a *Warning*, with any following instances during the competition resulting in a *Major Penalty*. During the *Driver-Controlled Period*, *Drive Team Coaches* and/or *Drivers* are allowed to hold the *Team's Driver Station* Android device and interact with it to select an Op Mode, view information displayed on the screen, and initialize, start, stop, and reset the *Robot*.

<G24> Robots Deliberately Detaching Parts – *Robots* may not deliberately detach parts during a *Match* or leave mechanisms on the *Playing Field* unless permitted by a Game-Specific rule. *Possessed* or *Controlled Scoring Elements* are not considered to be a part of the *Robot* for the purpose of this rule. The consequence of deliberately detaching a part is a *Minor Penalty* if it does not *Block* an opposing *Alliance Robot*, *Alliance Specific Scoring Element* or *Scoring Area*. If a deliberately detached component or mechanism affects gameplay by any *Robot*, the offending *Robot* will receive a *Major Penalty* and will be issued a *Yellow Card*. *Robot* parts that are released but remain connected by a tether are considered detached for the purposes of this rule.

Tethered components that move independently of the main *Robot* are considered a detached component and are illegal.

<G25> Robots Grasping Game Elements – *Robots* may not grab, grasp and/or attach to any *Game Element*, *Robot*, or structure other than *Scoring Elements*, unless specifically allowed by Game-Specific rule(s) listed in section 4.6.3. The first instance will result in a *Warning* with any following violations during the competition resulting in a *Major Penalty*.

<G26> Destruction, Damage, Tipping, etc. – *Robot* actions aimed at the destruction, damage, tipping over, or entanglement of *Robots* or *Game Elements* are not in the spirit of the *FIRST* Tech Challenge and are not allowed unless permitted by Game-Specific rules. However, *FIRST* Tech Challenge games are highly interactive. *Robot-to-Robot* contact and defensive gameplay should be expected. Some tipping, entanglement, and damage may occur as a part of normal gameplay. If the tipping, entanglement, or damage is ruled to be deliberate or chronic, the offending *Team* will receive a *Major Penalty* and a *Yellow Card*.

<G27> Removing Game Elements from the Playing Field – *Robots* may not deliberately remove *Game Elements* from the *Playing Field* during a *Match*. *Game Elements* that *Inadvertently* fall *Outside* the *Playing Field* will be returned to the *Playing Field* by field personnel at the earliest safe and convenient opportunity at a non-*Scoring* location approximately where it left the field. *Game Elements* removed from the *Playing Field* in an attempt to *Score* are also not subject to this *Penalty*. *Teams* deliberately removing *Game Elements* from the *Playing Field* will incur a *Minor Penalty* per *Game Element* removed from the *Playing Field*. Game-Specific rules listed in section 4.6.3 that address the removal of specified *Scoring Elements* from the *Playing Field* take precedence over this general game rule.

<G28> Pinning, Trapping, or Blocking Robots – A *Robot* may not cause an opposing *Alliance Robot* to become *Pinned*, *Trapped*, or *Blocked*. If a referee determines this rule is violated, the offending *Alliance* will receive a *Minor Penalty* for every five seconds that they are in violation. If a referee declares a *Pinning*, *Trapping*, or *Blocking* violation during the *Match*, the offending *Robot* must immediately move away at least 3 feet (0.9 m), approximately 1.5 *Tiles*, from the *Pinned*, *Trapped*, or *Blocked Robot*.

A *Robot* cannot incur this type of *Penalty* during the *Autonomous Period* unless it is determined by the *Referee* to be part of a deliberate strategy and will be penalized as described above. If the violation happens during the *Autonomous Period*, the first action done by the offending *Robot* during the *Driver-Controlled Period* must be to move away from the *Pinned*, *Trapped*, or *Blocked Robot* or a *Minor Penalty* will be assessed immediately and again for every five-seconds that they are in violation. Game-Specific rule(s) listed in section 4.6.3 that further define *Pinning*, *Trapping*, or *Blocking* take precedence over this general game rule.

The intent of this rule is that *Drive Teams* begin to immediately move their *Robots* away and have a five second grace period to move the required distance. The grace period is not permission to intentionally *Block* for up to five seconds.

<G29> Illegal Usage of Game Elements - *Robots* may not deliberately use *Game Elements* to ease or amplify the difficulty of any *Scoring* or game activity. A *Major Penalty* will be assessed for violations of this rule. Continued violations of this rule will quickly escalate to a *Yellow Card*.

<G30> Egregious Behavior – Egregious *Robot* or *Team* member behavior at the *Playing Field*, as determined by the referees, will result in a *Major Penalty* and issuance of a *Yellow Card* and / or *Red Card*. Subsequent violations will result in *Team Disqualification* from the competition. Egregious behavior includes, but is not limited to, repeated and/or flagrant violation of game rules, unsafe behavior or actions, and uncivil behavior towards *Drive Team*, competition personnel, or event attendees.

4.6.3 Game-Specific Rules

<GS1> General Rule Exceptions - The following instances of gameplay are Game-specific exceptions to General Game Rules in section 4.6.2:

- a) *Drive Teams* may interact with *Scoring Elements* in the *Loading Dock* at any time during the *Match* as an exception to rule <G22>.

- b) As a part of pre-Match Robot placement or post-Match Robot retrieval, Drive Teams may also place or retrieve their Team Shipping Element as an exception to rule <G12>.

<GS2> Descoring - Robots may not remove Freight or Team Shipping Elements On or In the opposing Alliance's:

- a) Storage Unit Area. Each violation results in a Minor Penalty per Scoring Element.
- b) Carousel. Each violation results in a Minor Penalty per Scoring Element.
- c) Alliance Shipping Hub. Each violation results in a Major Penalty per Scoring Element.
- d) Section of the Shared Shipping Hub. Each violation results in a Major Penalty per Scoring Element.

The intent of this rule is to prevent Robots from removing Scored Freight to the detriment of the opposing Alliance. Movement of Scored Freight on the Shared Shipping Hub is to be expected during normal Scoring activity. As Alliances attempt to Balance the Shared Shipping Hub in their Alliance's favor, the expectation is that some elements may shift as more elements are added to each side. Intentional removal of Freight from the opposing Alliance's side of the Shared Shipping Hub is not allowed. Descoring that affects the Shipping Hub Balance is described in rule <GS2>.

<GS3> Shipping Hub Constraints - The following are constraints placed on the Robots with respect to the Shipping Hubs:

- a) Robots may not intentionally relocate their Alliance Shipping Hub. Inadvertent and Inconsequential contact is allowed but intentional movement that affects gameplay is assessed a Major Penalty.
- b) The Shipping Hub Balance shall be determined only by the weight and position of the Shipping Hub, the Scored Freight, and the Scored Team Shipping Elements.
 - i. A Robot contacting its own Alliance Shipping Hub at the End of the Match will result in that Shipping Hub being considered Unbalanced.
 - ii. Robot Interference at any time that affects the final determination of the opposing Alliance Shipping Hub will result in that Shipping Hub being considered Balanced.
 - iii. A Robot interfering with the Shared Shipping Hub at the End of the Match will result in the Shared Shipping Hub being considered Unbalanced in favor of their opponent. If Robots from both Alliances are interfering, then neither Alliance will get the points for the Shared Shipping Hub being Unbalanced.
- c) Robots may not interact with the Shared Shipping Hub during the Autonomous Period. Each violation of this rule will result in a Minor Penalty.
- d) Robots may not intentionally relocate or rotate the Shared Shipping Hub. Inadvertent and Inconsequential contact is allowed but intentional movement that affects gameplay is assessed a Major Penalty.
- e) Robots cannot Interfere or interact with the opposing Alliance Shipping Hub or the opposing Alliance section of the Shared Shipping Hub. Each violation of this rule will result in a Major Penalty.

<GS4> Team Shipping Element Constraints - The following are constraints placed on the *Robots* with respect to the *Team Shipping Elements*:

- a) *Robots* may not intentionally place the *Team Shipping Element* on the *Shared Shipping Hub*. Each violation of this rule results in a *Major Penalty*.
- b) *Robots* may not *Interfere* with their opposing *Alliance's Capping* attempts. While a *Robot* has a *Possessed Team Shipping Element* In the outside edge of the *Shipping Hub*, it cannot be *Interfered* with. Each violation will result in a *Cap* being awarded plus a *Minor Penalty* to the offending *Robot*.
- c) *Robots* may not *Control* their opposing *Alliance's Team Shipping Elements*. Each violation of this rule results in a *Major Penalty*.

<GS5> Freight Constraints - The following are constraints placed on the *Robots* with respect to the *Freight*:

- a) *Freight* removed from the *Warehouse* must follow defined *Warehouse Operations*. *Pre-Loaded Freight* is considered to be already removed from the *Warehouse*.
- b) A *Robot* must be *Completely Outside* of the *Warehouse* to *Score Freight*.

Each violation of this rule will result in a *Minor Penalty*.

<GS6> Launching Scoring Elements - *Scoring Elements* may not be *Launched*. *Ducks* or *Team Shipping Elements* falling from the *Carousels* are exempt from this rule (depending on the circumstances, rule <GS9>b may still apply). Each violation of this rule results in a *Minor Penalty*.

<GS7> Carousel Constraints – *Robots* may not:

- a) Intentionally place items *On* the *Carousel*. Each violation of this rule results in a *Minor Penalty*.
- b) Contact the top or bottom surfaces of the *Carousel Platform*. *Robots* may only contact the *Carousel Rim*. An immediate *Minor Penalty* for each violation and an additional *Minor Penalty* for every 5 seconds of contact will be assessed.
- c) Contact a *Scoring Element* *On* the *Carousel*. A *Minor Penalty* is assessed for each violation.
- d) Interact or *Interfere* with the opposing *Alliance's Carousel*. Violations of this rule will result in a *Major Penalty* per occurrence.
- e) Interact or *Interfere* with the opposing *Alliance's Robot* when it is in contact with the *Carousel*. Violations of this rule will result in a *Major Penalty* per occurrence.

The intent of this rule is that *Robots* only interact with the *Carousel* at the *Rim*, incidental contact with the top or bottom of the *Carousel* will not be penalized.

<GS8> Control/Possession Limits of Scoring Elements - *Robots* may *Control* or *Possess* a maximum of one (1) *Freight* and one (1) *Team Shipping Element* at a time.

- a) *Plowing* through any quantity of *Scoring Elements* is allowed but *Herding* or directing *Scoring Elements* above the allowed limit to gain a strategic advantage (for example, *Scoring*, accessibility, defense) is not allowed. The *Penalty* for *Controlling* or *Possessing* more than the allowed quantity is an immediate *Minor Penalty* for each *Scoring Element* above the limit plus an additional *Minor Penalty* per *Scoring Element* in excess of the limit for each 5-second interval that this situation continues.

- b) A *Major Penalty* will be assessed for each *Scoring Element* that is *Scored* while a *Robot Controls* or *Possesses* more than the allowed quantity. Continued violation of this rule will quickly escalate to *Yellow Cards*.
- c) *Freight* already *Scored* in a *Robot's* own *Alliance Scoring Area* does not count towards the *Control/Possession* limit.
- d) During the *Autonomous Period*, *Robot* contact with their *Alliance's Barcodes (Duck or Team Shipping Element)* that are *On the Playing Field Floor* is considered *Plowing*.

<GS9> Delivery Constraints - The following are constraints placed on the *Robots* with respect to *Delivery*:

- a) *Delivered Ducks* and *Team Shipping Elements* must contact the floor before a *Robot* may *Control* them. Each violation of this rule results in a *Minor Penalty*. *Inadvertent* and *Inconsequential* contact with the *Robot* will not be penalized.
- b) Once the *Match begins*, *Ducks* and *Team Shipping Elements* may only be introduced onto the *Playing Field* via *Delivery*. Each violation of this rule results in a *Major Penalty*.
- c) *Drive Teams* may not place or interact with *Ducks* or *Team Shipping Elements* *On the Carousel* during the *Autonomous Period*. Each violation of this rule results in a *Major Penalty*.
- d) *Ducks* or *Team Shipping Elements* may only be *Delivered* onto the *Playing Field Floor* during the *Autonomous* and *End Game Periods* of a *Match*. Each violation of this rule results in a *Major Penalty*.
- e) Only one (1) *Duck* or *Team Shipping Element* is allowed *On the Carousel* at a time. Each violation of this rule receives a *Major Penalty*.
- f) *Ducks* or *Team Shipping Elements* on the *Carousel* must be in contact with the *Sweeper Plate* before a *Robot* can rotate the *Carousel*. Each violation of this rule results in a *Major Penalty*.
- g) Once the *Carousel* begins to move; the *Drive Team* can no longer touch a placed *Duck* or *Team Shipping Element* unless it falls off on its own outside of the *Field*. Each violation of this rule results in a *Major Penalty*. *Ducks* that fall outside the *Field* will be placed back in the *Loading Dock* by the *Drive Team* or by *Field Personnel* if out of reach by the *Drive Team*.
- h) *Drive Teams* may not interact with the *Carousel* (for example, touching, placing a *Duck* or *Team Shipping Element*) when the *Carousel* is in motion. Each violation earns a *Major Penalty*.
- i) Once a *Duck* or *Team Shipping Element* is *Delivered*, it is not eligible to be *Delivered* again.

<GS10> Autonomous Interference - *Robots* may not *Interfere* with the opposing *Alliance's Scoring* attempts during the *Autonomous Period*. A *Major Penalty* will be assessed for each occurrence.

4.7 Scoring Summary

The following table shows the possible *Scoring* achievements and their point values. The table is a quick reference guide and not a substitute for a thorough understanding of the game manual. All achievements are *Scored at Rest*.

Scoring Achievement	Autonomous Points	Driver-Controlled Points	End Game Points	Reference
<i>Carousel: Delivering a Duck</i>	10			4.5.2.1
<i>Parking: Robot In Storage Unit</i>	3			4.5.2.2a
<i>Parking: Robots Completely In Storage Unit</i>	6			4.5.2.2b
<i>Parking: Robot In Warehouse</i>	5			4.5.2.2c
<i>Parking: Robot Completely In Warehouse</i>	10			4.5.2.2d
<i>Freight Completely In Storage Unit</i>	2			4.5.2.3a
<i>Freight Completely On Shipping Hub</i>	6			4.5.2.3b
<i>Auto Bonus: Pre-Load Box Completely On randomized Level using Duck</i>	10			4.5.2.4
<i>Auto Bonus: Pre-Load Box Completely On randomized Level using Team Shipping Element</i>	20			4.5.2.5
<i>Freight Completely In Storage Unit</i>		1		4.5.3.1a
<i>Freight On Alliance Shipping Hub – Level 1</i>		2		4.5.3.1b
<i>Freight On Alliance Shipping Hub – Level 2</i>		4		4.5.3.1b
<i>Freight On Alliance Shipping Hub – Level 3</i>		6		4.5.3.1b
<i>Freight On Shared Shipping Hub</i>		4		4.5.3.1c
<i>Duck or Team Shipping Element Delivered</i>			6	4.5.4.1
<i>Alliance Shipping Hub: Balanced</i>			10	4.5.4.2a
<i>Shared Shipping Hub: Unbalanced</i>			20	4.5.4.2b
<i>Parking In Warehouse</i>			3	4.5.4.3a
<i>Parking Completely In Warehouse</i>			6	4.5.4.3b
<i>Capping: each Team Shipping Element</i>			15	4.5.4.4

4.8 Rule Summary

The following table shows the possible rule violations and their consequences. The table is a quick reference guide and not a substitute for a thorough understanding of the complete rule descriptions in section 4.6.

Rule #	Rule	Consequence	Warning Disable	Minor Penalty	Major Penalty	Card Issued
Safety Rules						
<S1>	Unsafe <i>Robot</i> or Damage to the <i>Playing Field</i> .	<i>Disable</i> if unsafe operation is likely to persist. Optional <i>Yellow Card</i> . Significant damage and/or delays may escalate to <i>Red Card</i> .	D*			YC* RC*
<S2>	Contact <i>Outside</i> the <i>Playing Field</i> .	Immediate <i>Yellow Card</i> and Optional <i>Disable</i> unless allowed by rule.	D*			YC
<S3>	<i>Drive Team</i> missing safety gear.	<i>Warning</i> and if not resolved within 30 seconds, the offending member(s) of the <i>Drive Team</i> must leave the <i>Competition Area</i> and may not be replaced.	W+	Per occurrence following <i>Team Warning</i>		
General Rules – Further definitions, no Penalties earned						
<G1>	<i>Autonomous</i> to <i>Driver-Controlled</i> <i>Period</i> transition					
<G2>	Certifying the <i>Score</i> at <i>End of the Match</i>					
<G3>	Forcing an opponent to break a rule					
<G4>	<i>Scoring Elements</i> <i>Controlled</i> or <i>Possessed</i> are part of the <i>Robot</i> for <i>Robot</i> location					
<G5>	<i>Scoring Elements</i> in contact with <i>Robots</i>	Points are not earned for any <i>Scoring Elements</i> in a <i>Scoring Area</i> in contact with <i>Robots</i> of the corresponding <i>Alliance</i> .				
<G6>	<i>Scoring Elements</i> in two or more <i>Areas</i>					
<G7>	<i>Disabled Robot</i> eligibility					
<G8>	<i>Playing Field</i> Tolerances					
<G9>	<i>Match</i> Replay					
<G10>	<i>Inadvertent</i> and <i>Inconsequential</i>					

Rule #	Rule	Consequence	Warning Disable	Minor Penalty	Major Penalty	Card Issued
General Rules – Pre-Match Penalties						
<G11>	Drive Team using disallowed electronic communication	Warning followed by a Minor Penalty.	W	1x		
<G12>	Measure, test, or adjust Game Elements. Playing Field inspection to determine Score	Minor Penalty for pre-Match or post-Match violations. Major Penalty if delay start of Match. Yellow Card if outside of normal Match play.		1x	1x	YC
<G13>	Pre-Match Robot placement.	Minor Penalty if Teams delay the start of a Match. Major Penalty for a significant delay.		1x	1x*	
<G14>	Robot starting volume.	Robot is removed from the Playing Field if not resolved within 30 seconds.				
<G15>	Robot setup alignment devices/Match Delay.	Minor Penalty for each offense.		1x		
<G16>b	Drive Team member(s) leaving the Alliance Station.	Warning for the first instance with any following instances resulting in a Minor Penalty.	W	1x		
<G16>c	Drive Teams distracting and/or interfering with each other or the off-Field Scoring Elements.	Immediate Major Penalty and a possible Yellow Card.			1x	YC*
<G17>	Delay caused by the removal of Robots or damage to the Playing Field and Game Elements from Robots.	A Minor Penalty will be assessed.		1x		
General Rules – Gameplay Penalties						
<G18>	Starting Gameplay Early.	Minor Penalty with the option of a Major Penalty if the early start results in a competitive advantage for the offending Alliance.		1x	1x*	

Rule #	Rule	Consequence	Warning Disable	Minor Penalty	Major Penalty	Card Issued
<G19>	Late Start of the Autonomous Period.	Minor Penalty with the option of a Major Penalty if the late start results in a competitive advantage for the offending Alliance.		1x	1x*	
<G20>	Robot is not Parked at the end of period.	Minor Penalty and the actions of the Robot that occur after the end of gameplay do not count towards their Alliance's Score. Major Penalty if the late stop results in a competitive advantage for the offending Alliance.		1x	1x*	
<G21>	Robot control during Autonomous Period / Early stopping of the Autonomous code.	Major Penalty. Achievements earned during that time result in zero Score			1x	
<G22>	Drive Team contact with the Playing Field, Game Element, or Robot.	Warning for the first instance with any following instances resulting in a Minor Penalty. Optional Yellow Card if contact affects Scoring and/or gameplay.	W	1x		YC*
<G23>	Drive Team Coach Driver Station control.	Warning for the first instance with any following instances resulting in a Major Penalty.	W		1x	
<G24>	Robots deliberately detaching parts.	Minor Penalty. Major Penalty and a Yellow Card if it affects gameplay.		1x	1x	YC
<G25>	Robots illegally grasping Game Elements.	Warning for the first instance with any following instances resulting in a Major Penalty.	W		1x	
<G26>	Destruction, damage, tipping, etc.	Deliberate or chronic violations of this rule will receive a Major Penalty and a Yellow Card.			1x	YC
<G27>	Deliberately removing Game Elements from the Playing Field.	Minor Penalty per Game Element deliberately removed from the Playing Field.		1x		
<G28>	Pinning, Trapping, or Blocking for more than 5-seconds in the Driver-Controlled Period.	Minor Penalty for every five seconds the Robot violates this rule.		1x+		

Rule #	Rule	Consequence	Warning Disable	Minor Penalty	Major Penalty	Card Issued
<G29>	Illegal Use of <i>Game Elements</i> to ease or amplify <i>Scoring</i> .	<i>Major Penalty</i> will be assessed with any following instances resulting in a <i>Yellow Card</i> .			1x	YC
<G30>	Egregious behavior.	<i>Major Penalty</i> plus a <i>Yellow</i> and/or <i>Red Card</i> . Possible <i>Match Disqualification</i> . Subsequent violations result in <i>Team Disqualification</i> for the competition.			1x	YC RC DQ
Game-Specific Rules – Gameplay Penalties						
<GS2>a	Descoring <i>Opposing Alliance's Storage Unit</i>	<i>Minor Penalty</i> per <i>Scoring Element</i>		1x		
<GS2>b	Descoring <i>Opposing Alliance's Carousel</i>	<i>Minor Penalty</i> per <i>Scoring Element</i>		1x		
<GS2>c	Descoring <i>Opposing Alliance's Shipping Hub</i>	<i>Major Penalty</i> per <i>Scoring Element</i>			1x	
<GS2>d	Descoring <i>Opposing Alliance's</i> section of <i>Shared Shipping Hub</i>	<i>Major Penalty</i> per <i>Scoring Element</i>			1x	
<GS3>a	Relocate <i>Alliance Shipping Hub</i>	<i>Major Penalty</i> for each offense			1x	
<GS3>c	Interact with <i>Shared Shipping Hub</i> during <i>Autonomous</i>	<i>Minor Penalty</i> for each offense.		1x		
<GS3>d	Relocate/rotate <i>Shared Shipping Hub</i>	<i>Major Penalty</i> for each offense			1x	
<GS3>e	<i>Interfere</i> with <i>Opposing Alliance Shipping Hub</i>	<i>Major Penalty</i> for each offense			1x	
<GS4>a	Placing <i>Team Shipping Element</i> on <i>Shared Shipping Hub</i>	<i>Major Penalty</i> for each offense			1x	
<GS4>b	<i>Interfere</i> with <i>Opposing Alliance Capping</i>	<i>Cap</i> awarded to <i>Opposing Alliance</i> plus <i>Minor Penalty</i>		1x / <i>Cap</i>		
<GS4>c	<i>Controlling</i> <i>Opposing Alliance's Team Shipping Element</i>	<i>Major Penalty</i> for each offense			1x	

Rule #	Rule	Consequence	Warning Disable	Minor Penalty	Major Penalty	Card Issued
<GS5>	Violating <i>Warehouse Operations</i>	<i>Minor Penalty</i> for each offense		1x		
<GS6>	<i>Launching Scoring Elements</i>	<i>Minor Penalty</i> for each offense		1x		
<GS7>a	<i>Robots</i> placing items on <i>Carousel</i> .	<i>Minor Penalty</i> for each offense		1x		
<GS7>b	<i>Robot</i> contact on top or bottom of <i>Carousel</i> .	Immediate <i>Minor Penalty</i> for each offense plus additional <i>Minor Penalty</i> every 5 seconds		1x+		
<GS7>c	<i>Contact</i> with <i>Scoring Element</i> while on <i>Carousel</i> .	<i>Minor Penalty</i> for each offense		1x		
<GS7>d	<i>Interact</i> or <i>Interfere</i> with <i>Opposing Alliance's Carousel</i> .	<i>Major Penalty</i> for each offense			1x	
<GS7>e	<i>Interact</i> or <i>Interfere</i> with <i>Opposing Alliance's Robot</i> while in contact with <i>Carousel</i> .	<i>Major Penalty</i> for each offense			1x	
<GS8>a	<i>Herding Scoring Elements</i>	Immediate <i>Minor Penalty</i> for each offense plus additional <i>Minor Penalty</i> every 5 seconds		1x+		
<GS8>b	<i>Scoring</i> while in <i>Possession</i> of excess quantity.	<i>Major Penalty</i> for each offense. May escalate to <i>Yellow Cards</i>			1x	YC
<GS9>a	<i>Duck/ Team Shipping Element</i> must touch floor before a <i>Robot</i> can <i>Control</i> it.	<i>Minor Penalty</i> for each offense		1x		
<GS9>b	<i>Delivery</i> only by <i>Carousel</i>	<i>Major Penalty</i> for each offense			1x	
<GS9>c	Placing <i>Ducks/ Team Shipping Element</i> on <i>Carousel</i> during <i>Autonomous</i>	<i>Major Penalty</i> for each offense			1x	
<GS9>d	<i>Delivery</i> only during <i>Autonomous</i> or <i>End Game</i>	<i>Major Penalty</i> for each offense			1x	
<GS9>e	Only one <i>Duck/ Team Shipping Element</i> at a time.	<i>Major Penalty</i> for each offense			1x	

Rule #	Rule	Consequence	Warning Disable	Minor Penalty	Major Penalty	Card Issued
<GS9>f	<i>Duck</i> not loaded correctly	<i>Major Penalty</i> for each offense			1x	
<GS9>g	<i>Drive Team</i> touching the <i>Duck</i> while <i>Carousel</i> in motion	<i>Major Penalty</i> for each offense			1x	
<GS9>h	<i>Drive Team</i> touching <i>Carousel</i> when in motion	<i>Major Penalty</i> for each offense			1x	
<GS10>	<i>Interfering</i> with <i>Opposing Alliance's Scoring</i> during <i>Autonomous Period</i>	<i>Major Penalty</i> for each offense			1x	

Table Key	
W: <i>Warning</i>	1x: <i>Penalty</i> at single cost
D: <i>Robot Disabled</i>	1x+: <i>Penalty</i> at single cost every 5 seconds
YC: <i>Yellow Card</i> issued	2x: <i>Penalty</i> at double cost
RC: <i>Red Card</i> issued	* Indicates optional
DQ: <i>Disqualification</i>	

Appendix A – Resources

Game Forum Q&A

<https://ftc-qa.firstinspires.org/>

Anyone may view questions and answers within the *FIRST*® Tech Challenge game Q&A forum without a password. To submit a new question, you must have a unique Q&A system user name and password for your team.

Volunteer Forum

Volunteers can request access to role specific volunteer forums by emailing FTCTrainingSupport@firstinspires.org. You will receive access to the forum thread specific to your role.

FIRST Tech Challenge Game Manuals

Part 1 and 2 - <https://www.firstinspires.org/resource-library/ftc/game-and-season-info>

FIRST Headquarters Pre-Event Support

Phone: 603-666-3906

Mon – Fri

8:30am – 5:00pm

Email: Firsttechchallenge@firstinspires.org

FIRST Websites

FIRST homepage – www.firstinspires.org

[FIRST Tech Challenge Page](#) – For everything *FIRST* Tech Challenge.

[FIRST Tech Challenge Volunteer Resources](#) – To access public volunteer manuals.

[FIRST Tech Challenge Event Schedule](#) – Find *FIRST* Tech Challenge events in your area.

FIRST Tech Challenge Social Media

[FIRST Tech Challenge Twitter Feed](#) - If you are on Twitter, follow the *FIRST* Tech Challenge Twitter feed for news updates.

[FIRST Tech Challenge Facebook page](#) - If you are on Facebook, follow the *FIRST* Tech Challenge page for news updates.

[FIRST Tech Challenge YouTube Channel](#) – Contains training videos, game animations, news clips, and more.

[FIRST Tech Challenge Blog](#) – Weekly articles for the *FIRST* Tech Challenge community, including outstanding volunteer recognition!

[FIRST Tech Challenge Team Email Blasts](#) – contain the most recent *FIRST* Tech Challenge news for teams.

Feedback

We strive to create support materials that are the best they can be. If you have feedback about this manual, please email firsttechchallenge@firstinspires.org. Thank you!

Appendix B – Playing Field Details

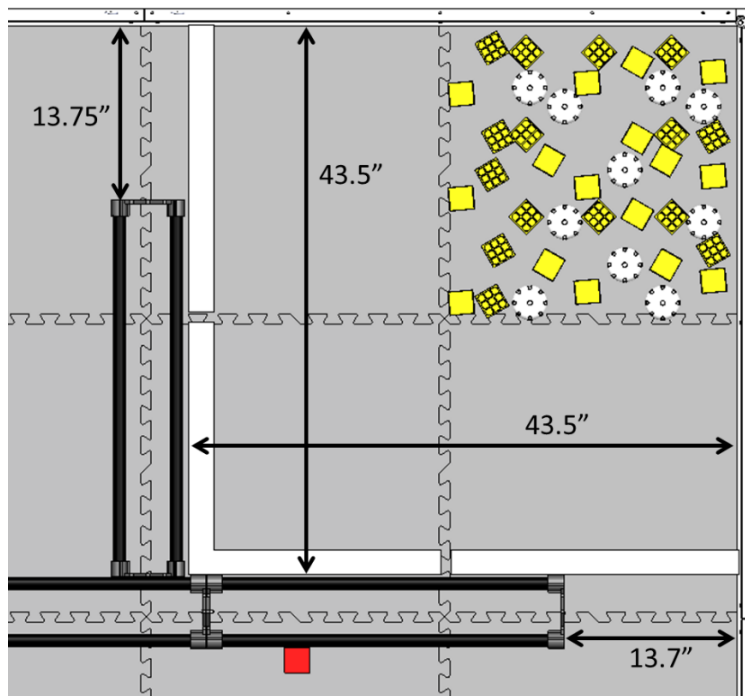

Note: Freight that is placed into the Warehouse during Pre-Match Setup will be placed Completely In the corner Tile.

B-1 Warehouse

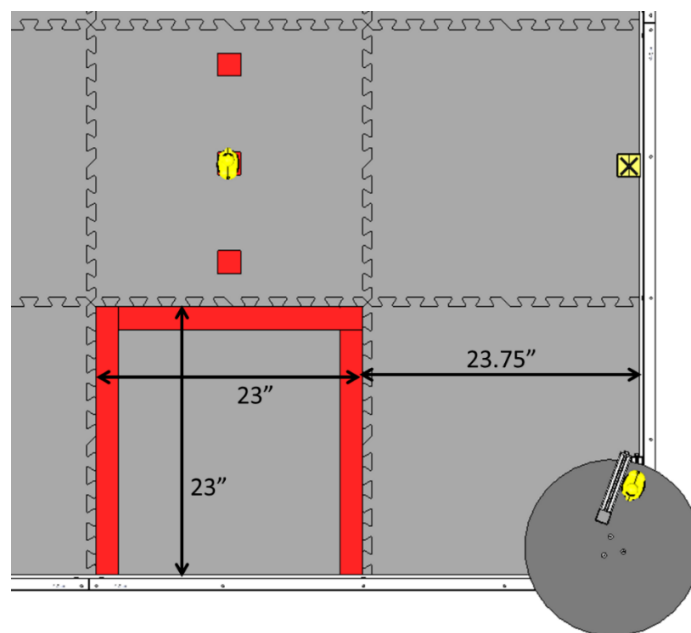

B-2 Storage Unit

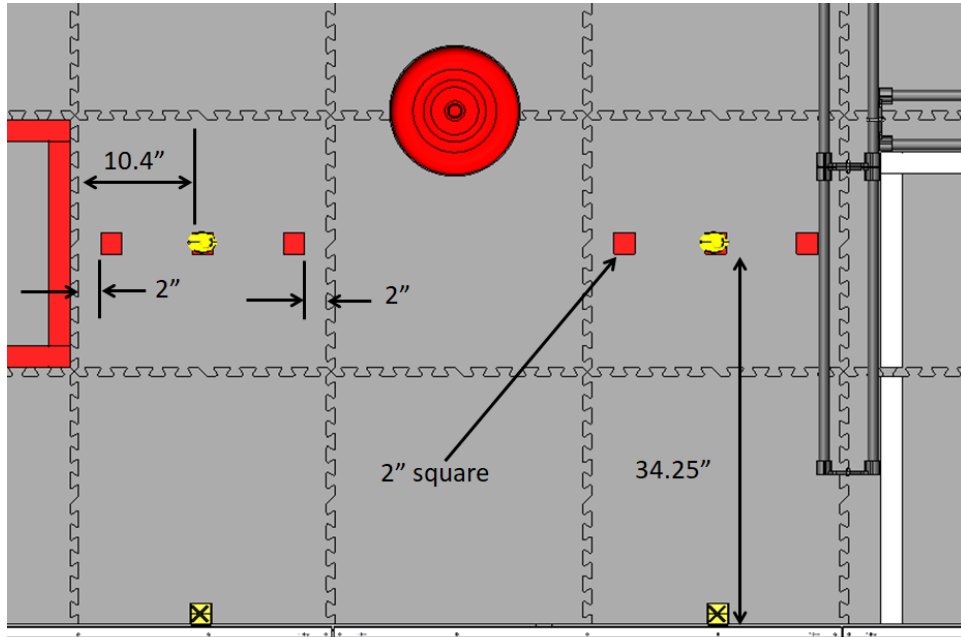

B-3 Barcode Locations

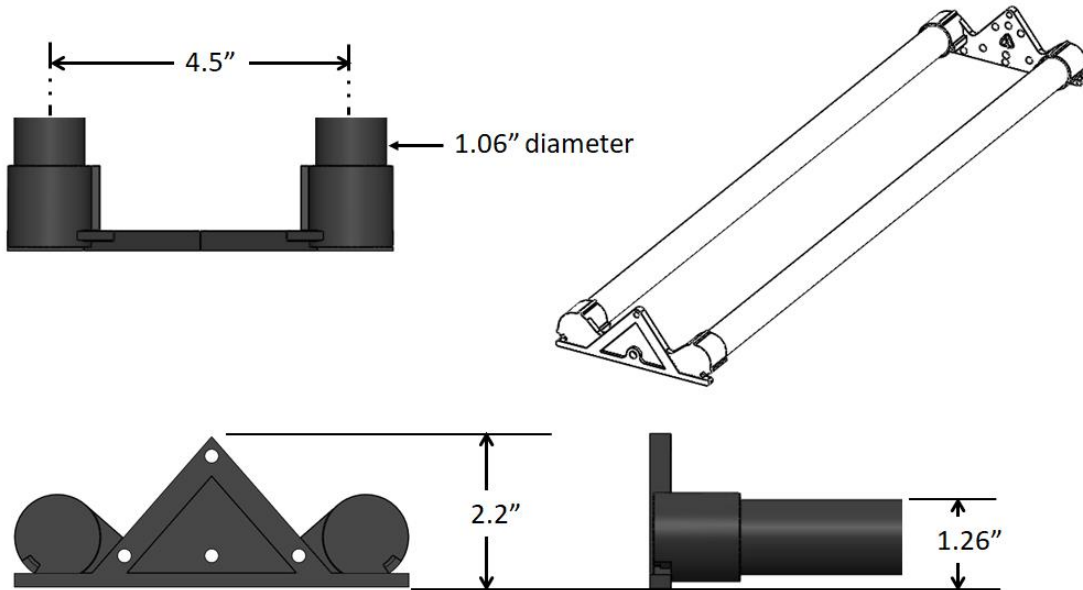

B-4 Barrier

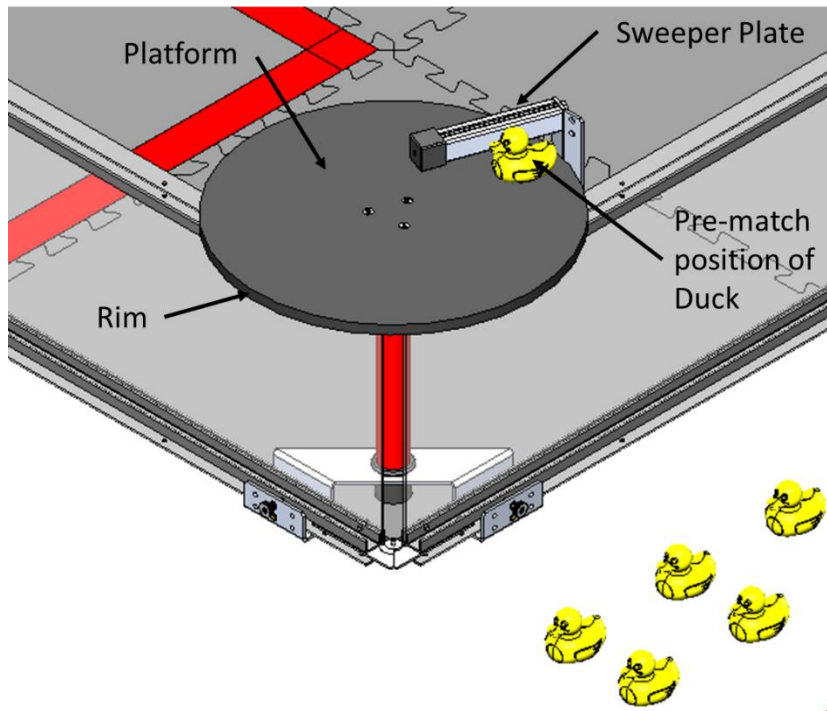

B-5 Carousel

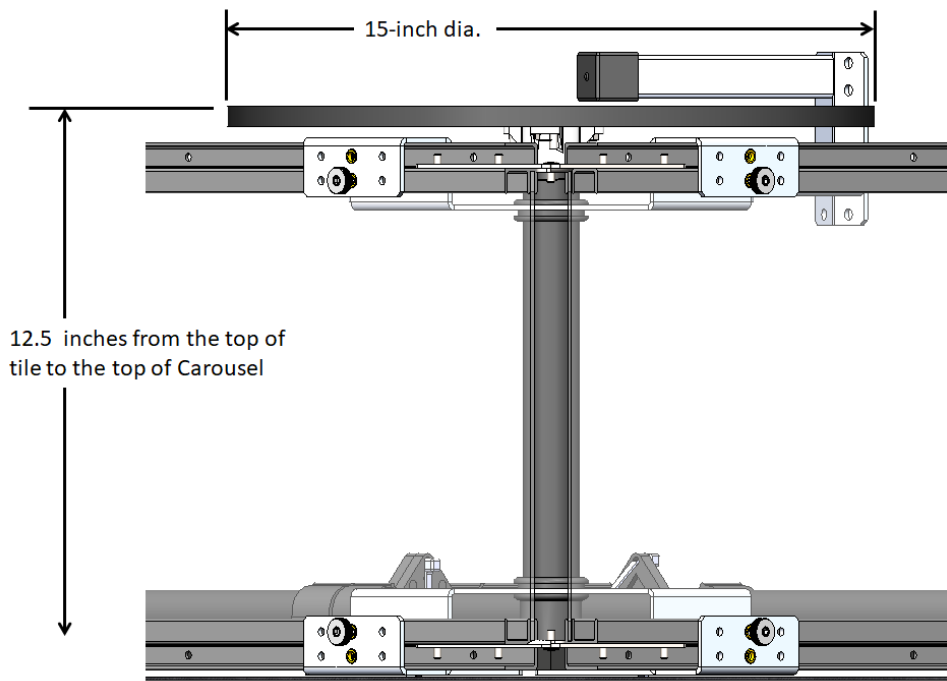

B-6 Carousel

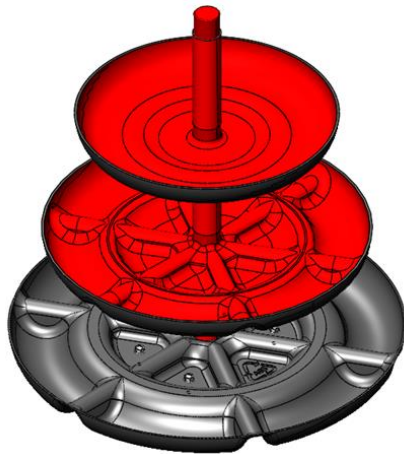

Alliance Shipping Hub (red)

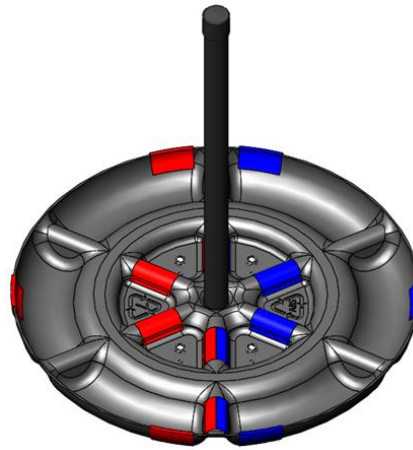

Shared Shipping Hub

B-7 Shipping Hubs

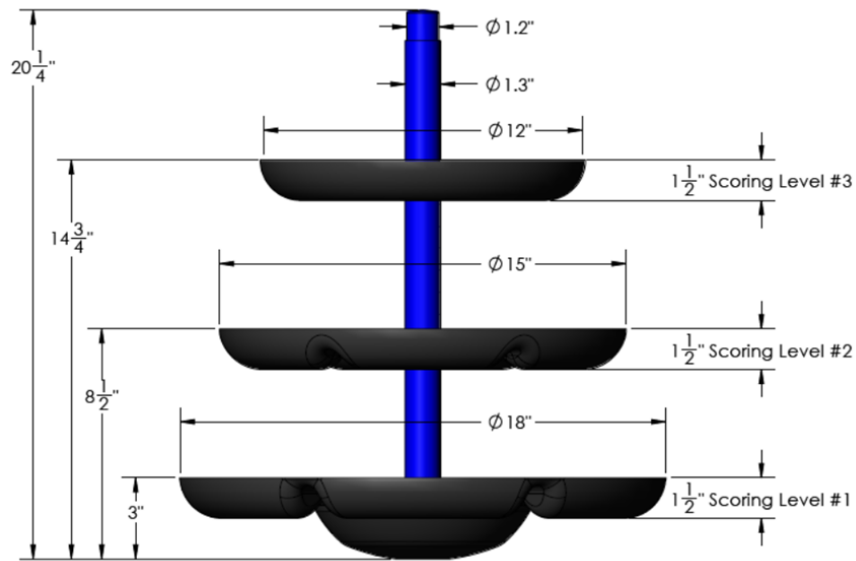

B-8 Alliance Shipping Hub

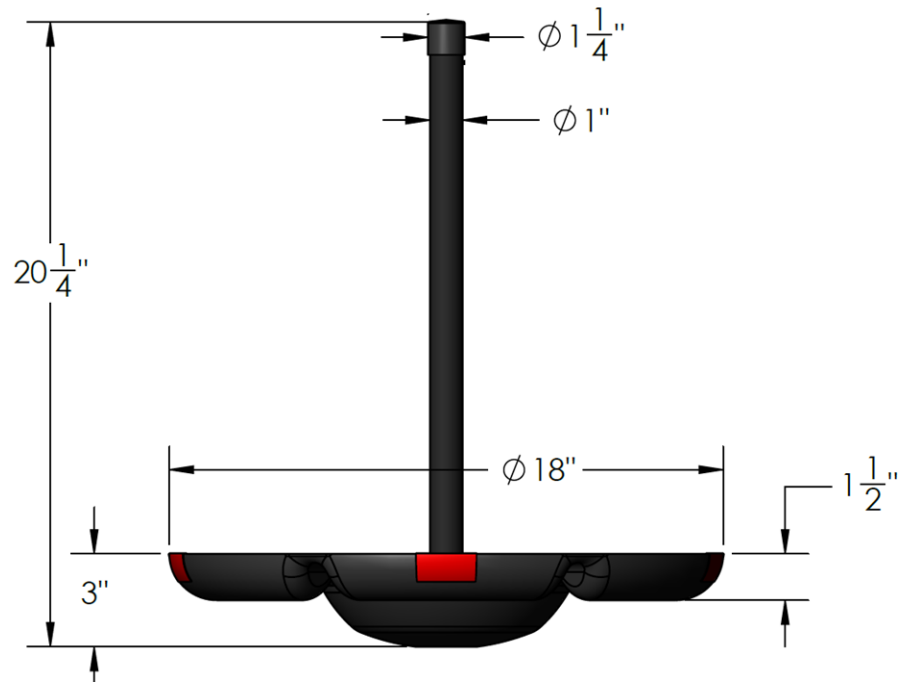

B-9 Shared Shipping Hub

Appendix C – Scoring Elements



Cargo
2.75" Diameter

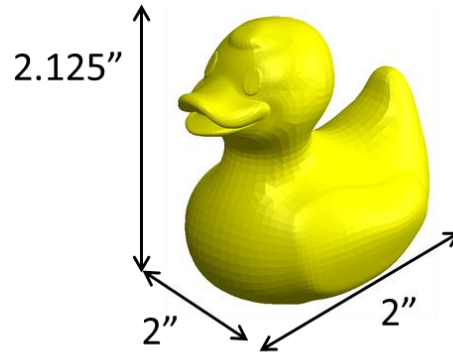

Duck

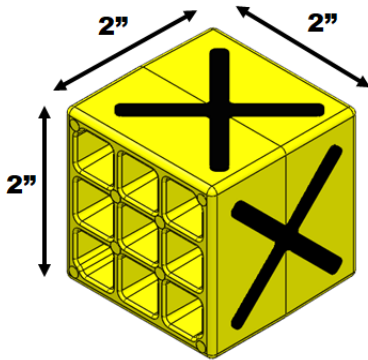

Pre-Load Box

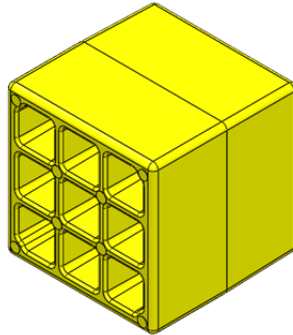

Light Box

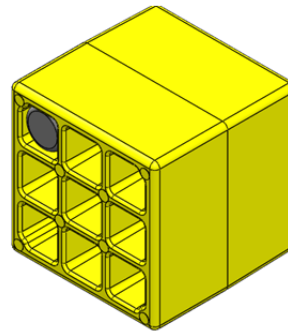

Medium Box

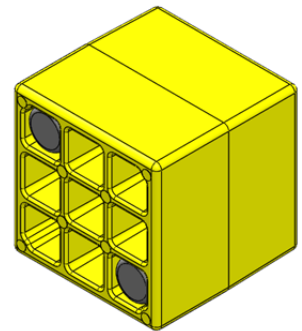

Heavy Box

C-1 Freight

Appendix D – Randomization

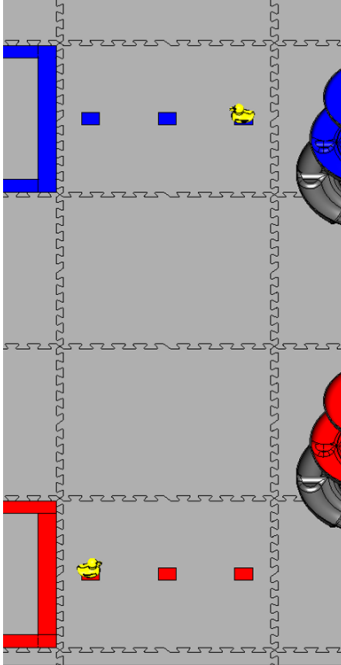

Scoring Level 1

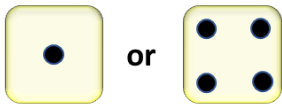

Dice Roll

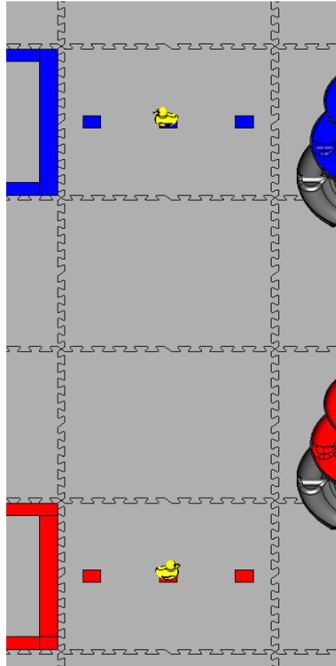

Scoring Level 2

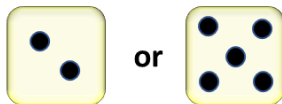

Dice Roll

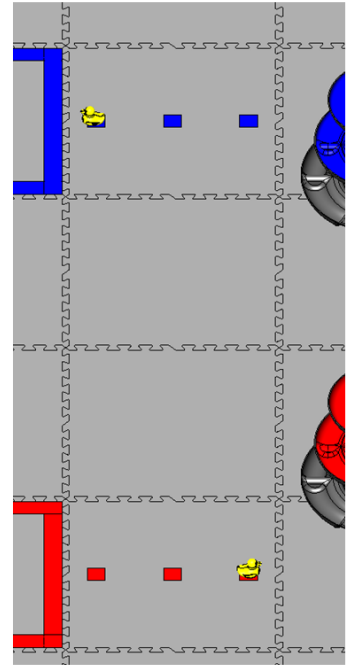

Scoring Level 3



Dice Roll

D-1 - Randomization

Orientation of the *Duck* during field setup is as shown.

Appendix E – Scoring Examples

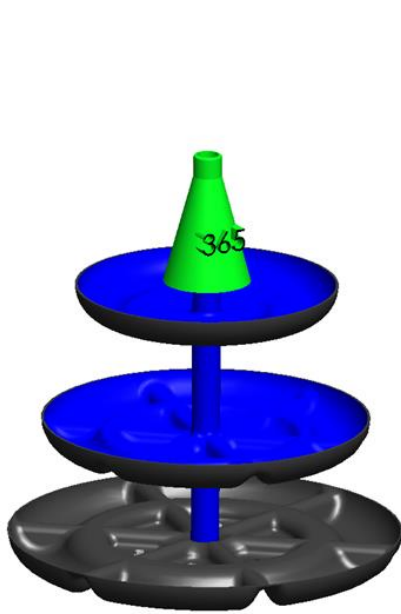

One (1) Team Shipping Element Scored

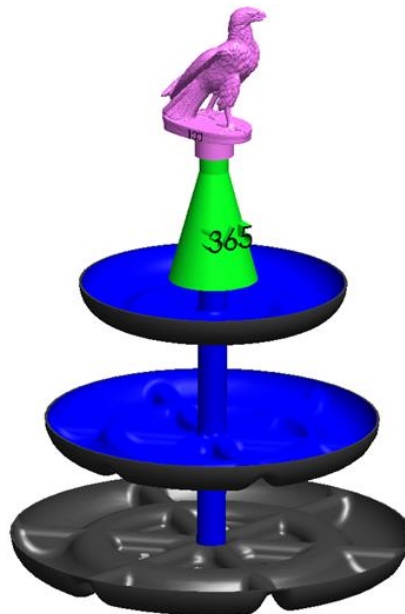

Two (2) Team Shipping Elements Scored

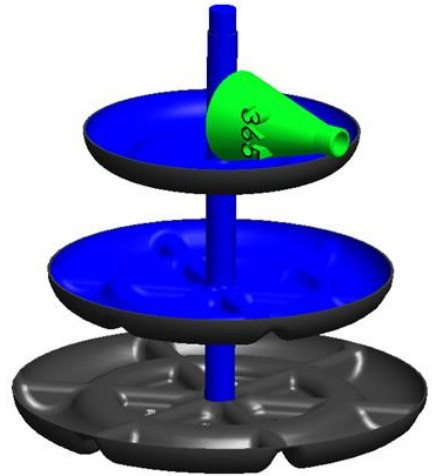

Zero (0) Team Shipping Elements Scored

E-1 Team Shipping Element Scoring

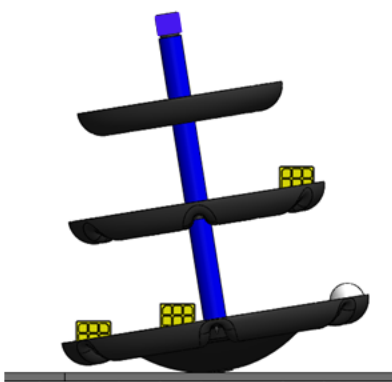

Balanced

The rim of the Hub is not in contact with the floor

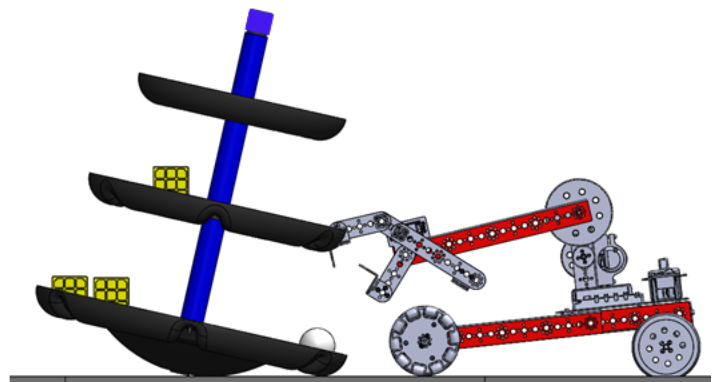

Balanced

Robot in contact with opposing Alliance's Hub

E-2 Balanced

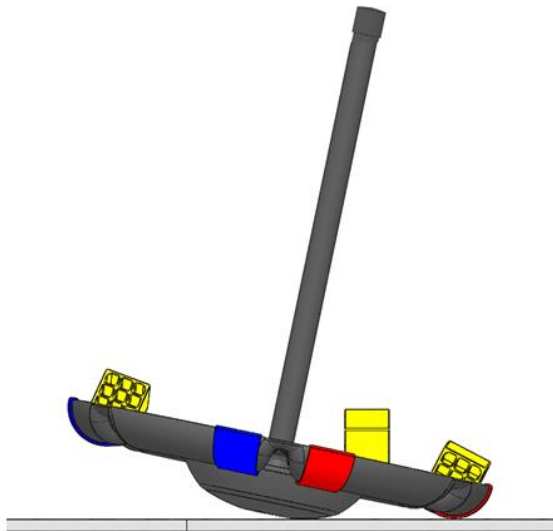

Unbalanced
Red Alliance earns Bonus Points

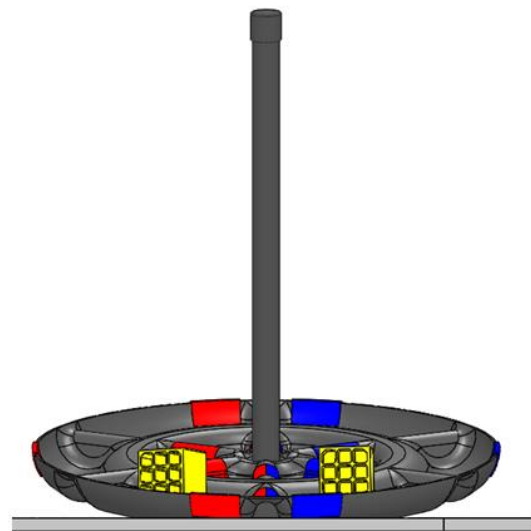

Floor Contact is between the Blue and Red Tape
Neither Alliance earns Bonus Points

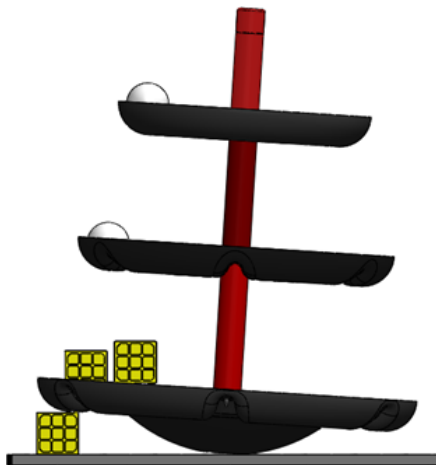

Unbalanced
Hub is in Contact with Unscored Freight

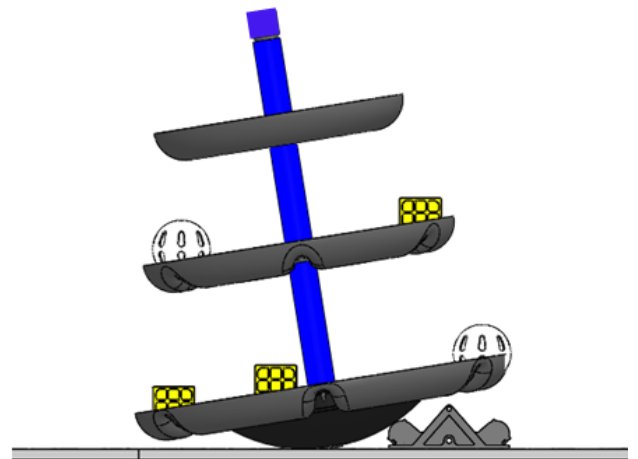

Unbalanced
Hub is in contact with the Barrier

E-3 Unbalanced (part 1)

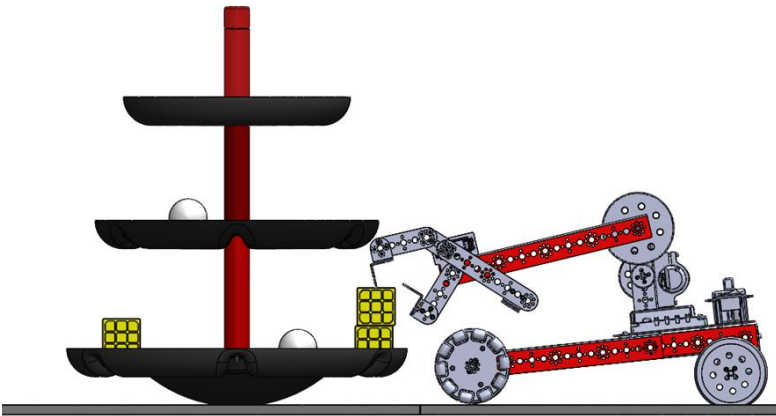

Unbalanced
Robot in contact with its own Shipping Hub

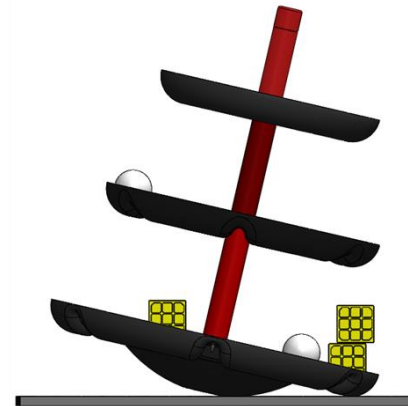

Unbalanced
The rim of the Hub is in contact with the floor

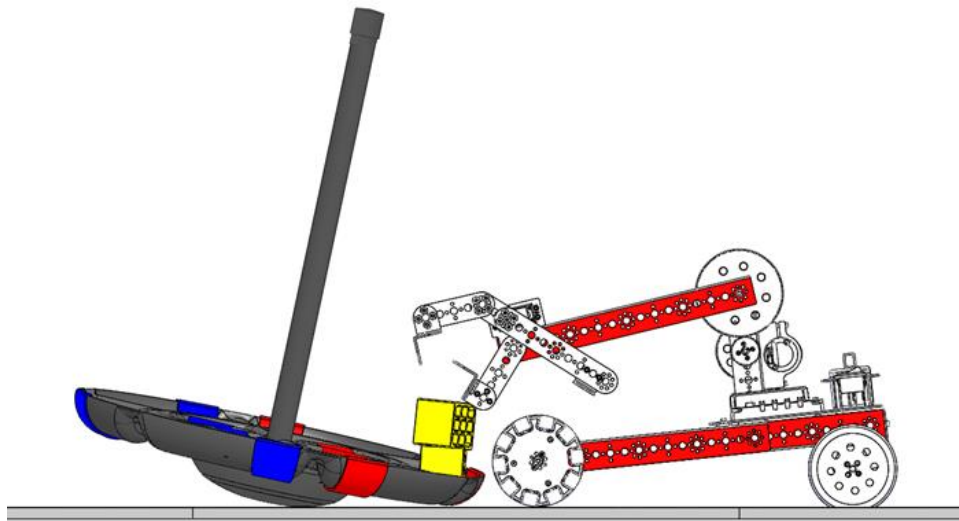

Unbalanced
Blue Alliance earns Bonus Points

E-3 Unbalanced (part 2)

Appendix F – Navigation Images



Image 1
Blue Alliance Wall



Image 4
Red Alliance Wall



Image 2
Audience Wall
Blue Side



Image 3
Audience Wall
Red Side

Image 1- The center of the image is on the *Playing Field Wall* closest to the blue *Alliance Station* and is aligned to the center of the fourth *Tile* in from the *Playing Field Wall* closest to the audience.

Image 2 - The center of the image is on the *Playing Field Wall* closest to the *Audience* and is aligned to the center of the second *Tile* in from the blue *Alliance Station*.

Image 3 - The center of the image is on the *Playing Field Wall* closest to the *Audience* and is aligned to the center of the second *Tile* in from the red *Alliance Station*.

Image 4 - The center of the image is on the *Playing Field Wall* closest to the red *Alliance Station* and is aligned to the center of the fourth *Tile* in from the *Playing Field Wall* closest to the audience.

Do not print the images from this manual for practice purposes, as they are not to the same scale as *Teams* will see in actual competition. Please refer to the [website](#) for printable versions of these images.