



PRESENTING SPONSOR



2017-2018 *FIRST*[®] RELIC RECOVERY *sm* Field Setup Guide

Rev 1.0

AndyMark Field Layout and Finishing Guide for 2017-2018 *FIRST*[®] Tech Challenge

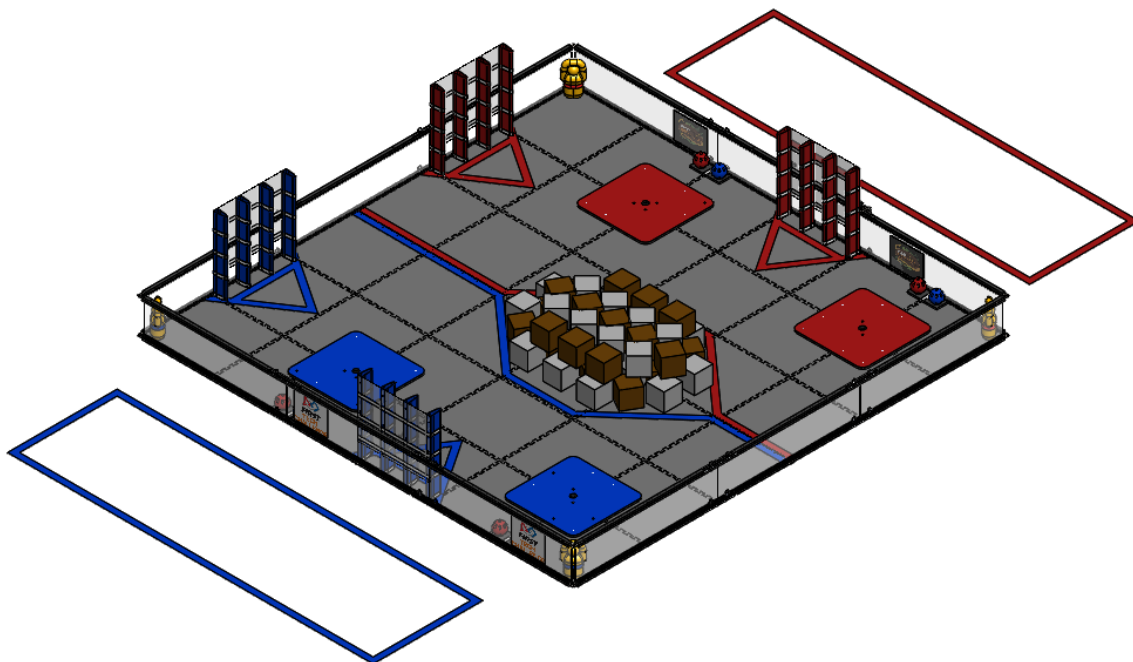

This guide contains instructions for setting up the Field Elements for the 2017-2018 *FIRST*® Tech Challenge Game

***FIRST*® RELIC RECOVERYSM Presented by Qualcomm® Incorporated**

Read through all the instructions and take a parts inventory before you begin to assemble and setup the game elements!

REVISION HISTORY











Rev.	Date	Description
1.0	8/31/17	Original Release



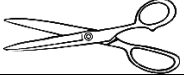

CAUTION!

Edges of field parts may be sharp. File or deburr sharp corners or edges as needed.



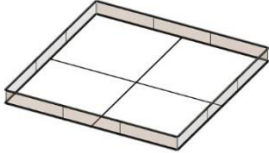

TOOLS NEEDED

Component	QTY	Part Photo
Safety Equipment	As Needed	
3/8" Wrench, or ratchet	1	
Adjustable Wrench	1	
Utility Knife	1	
5/32 Hex Key Driver	1	
File	1	
Scissors	1	
Diagonal Cutters	1	
Tape Measure	1	
Color Printer	1	

FULL FIELD REQUIREMENTS

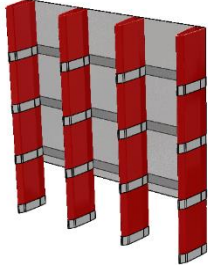
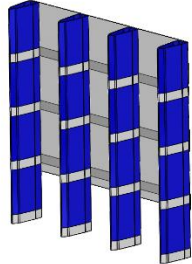
Component	Part #	QTY	Part Photo
FIRST Tech Challenge Field Perimeter	am-0481a	1	
5/8" Gray Soft Tiles	am-2499-36	36	



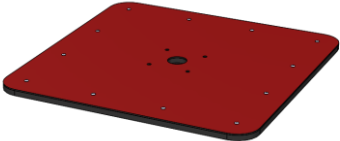
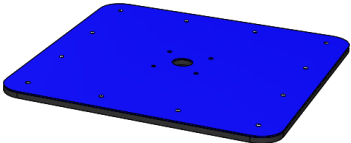

Competition Field Components

Component	Part #	QTY	Part Photo
RED Cryptobox Assembly	See Field Assembly Guide for assembly instructions.	2	
BLUE Cryptobox Assembly	See Field Assembly Guide for assembly instructions.	2	
Beam Clamp	am-3177	8	
Cable Tie	am-1067	8 needed each time the field is setup	
Lower Clip	am-3586	8	
RED Balancing Stone Assembly	See Field Assembly Guide for assembly instructions.	2	
BLUE Balancing Stone Assembly	See Field Assembly Guide for assembly instructions.	2	

Brown Glyphs	am-3574	24	
Gray Glyphs	am-3573	24	
RED Relic	am-3363R	2	
BLUE Relic	am-3363B	2	
RED Jewel	am-3364R	4	
BLUE Jewel	am-3364B	4	
RED Mat	am-3364R	1	
BLUE Mat	am-3364B	1	
Jewel Holder	am-3593	4	
2" "Red" Gaffers Tape	am-2946	as needed	

<p>2" "Electric Blue" Gaffers Tape</p>	<p>am-2947</p>	<p>as needed</p>	
<p>1" White Gaffers Tape</p>	<p>am-3617</p>	<p>as needed</p>	
<p>Cardstock for Vision Targets (Printed from FIRST Resource Library)</p>		<p>24</p>	
<p>Command Mini Hooks P/N: 17006-VP For use with AndyMark, IFI and Logo Loc Perimeters</p>	<p>P/N: 17006-VP</p>	<p>8</p>	
<p>Velcro® Dots For use with early generation AndyMark Perimeters</p>	<p>Roughly 3/4" diameter or larger</p>	<p>1 pack</p>	
<p>Clear Page Protection Sleeves</p>	<p>Similar tp Staples P/N 40713</p>	<p>12</p>	
<p>Non Skid pad (for Mats when taping to floor isn't allowed)</p>	<p>Sections 3x5ft are suggested</p>	<p>2</p>	

Match Timer Components

Component	Detail	QTY	Part Photo
Laptop/Netbook	Running Java 1.7 or higher	1 per field	
Field Display Monitor	Roughly a 17" monitor or bigger	1 per field	
Power	For Laptops and Monitors	1 set per field	
Video Cables	For connecting Monitors to laptop	1 set	
Computer Speakers	For match sound effects	1 set per field	

Part 1: Setting up the Floor and Field Perimeter

Step 1-1: Lay the tiles with the **smooth** surface facing up in a 6x6 grid pattern.

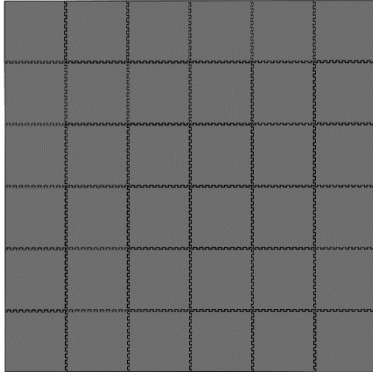

Step 1-2: Critical Mandatory Step: Trim all outer tabs from the 20 Soft Tiles on the outside edges of the field.

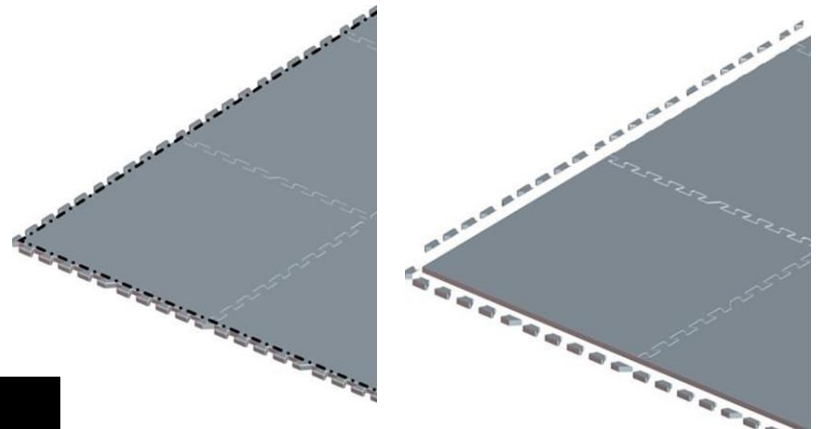

NOTE: Lay the tiles out and mark the outer edge to be cut. Use a sharp utility knife and a straight edge or a band saw (if available) to get a smooth clean edge.

Step 1-3 Optional: Locate the following locations on the floor. In order to get the Balancing stone to fit, the corners of the tiles may need to be trimmed.

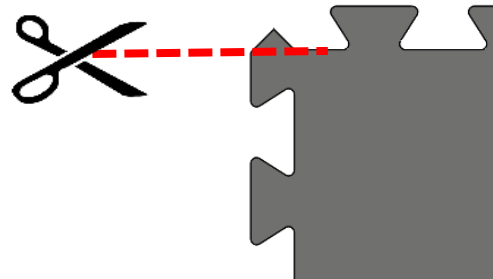
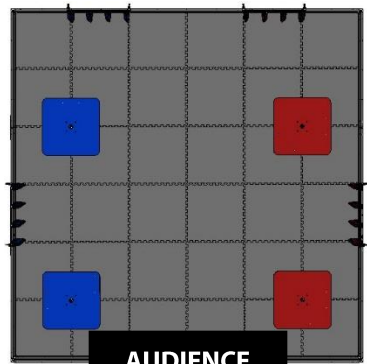

Step 1-4: Note that there are several **FIRST** Tech Challenge Perimeter wall designs. The wall designs fall into two categories. The smooth/non-cavity sides should face towards the inside of the Playing Field as shown in the illustration.

Perimeter	Wall Design Categories	Wall Height
AndyMark (current)	Smooth on one side and an open cavity on the other side	12.125"
IFI Perimeter	Smooth on one side and an open cavity on the other side	11.5"
Logo Loc Perimeter	Symmetrical inside and outside surfaces	12.375"

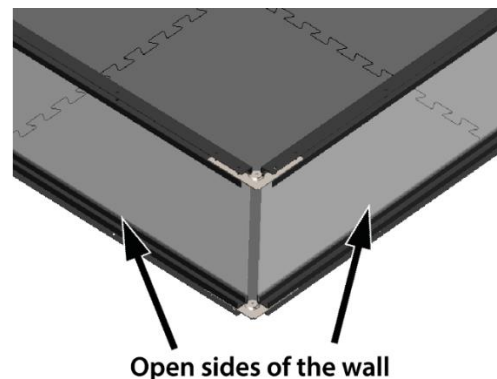
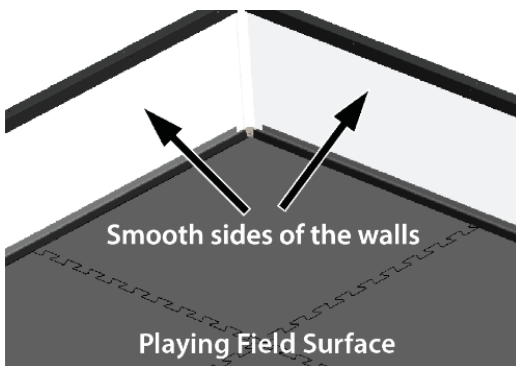

NOTE: If using the AndyMark Field Perimeter, ensure that straps are installed to keep walls in place during game play.

Part 2: General Layout and Orientation

MATCH TIMER
DISPLAY TABLE

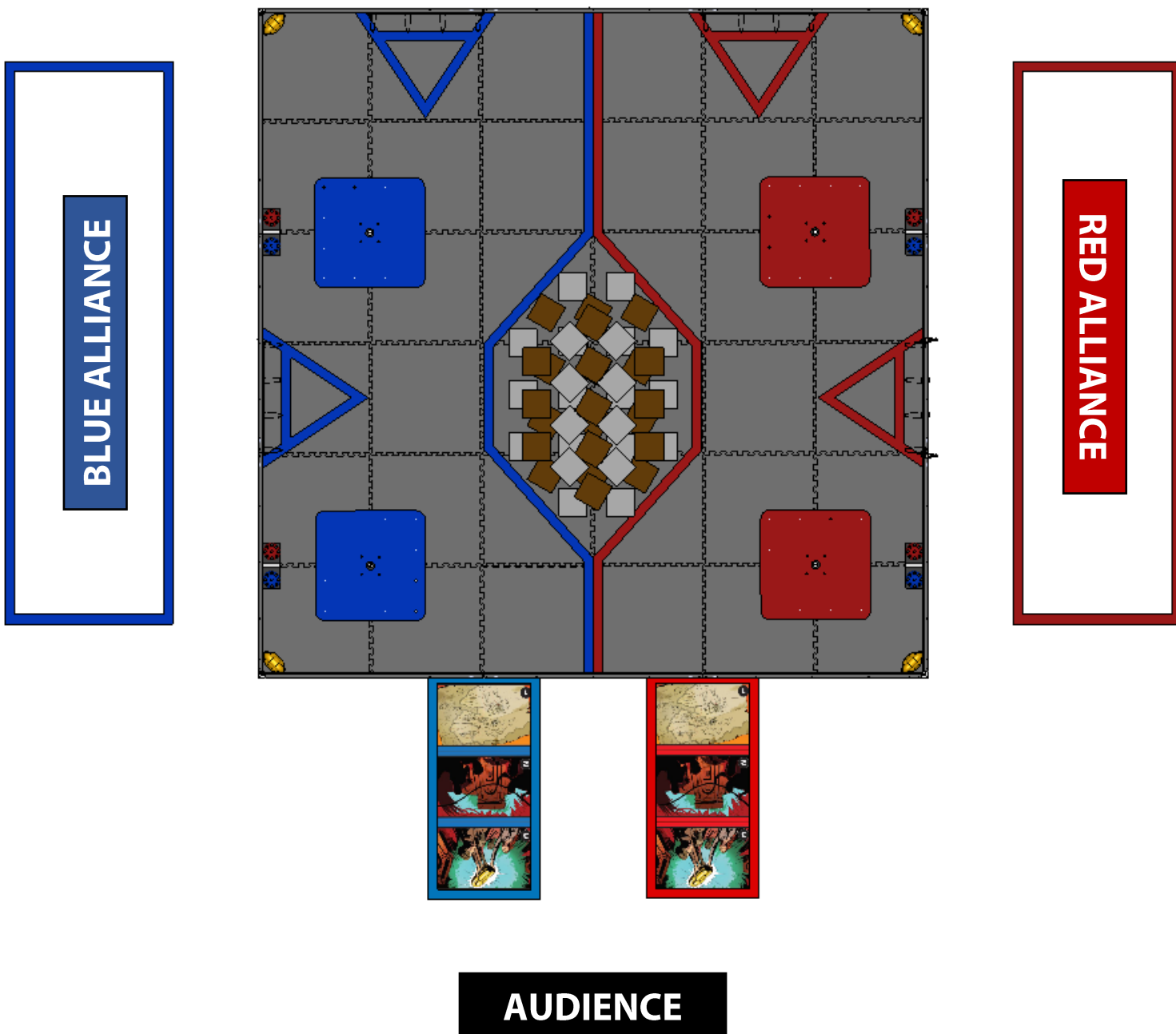

NOTE: The Match Timer Display table should include the timer screen as described in section 10. This should be placed to ensure that the Teams are able to see the clock and hear the timer sounds for each period of the Match.

Part 3: Cryptobox Placement

FIRST® RELIC RECOVERYSM is played with two RED and two BLUE Cryptoboxes on the field. Build instructions can be found in the Field Assembly Guide. Each Cryptobox should be placed inside of the field as shown with the plastic back plate at the top. One RED and one BLUE Cryptobox should be centered on the second tile in from the perimeter wall as shown. The second RED and BLUE Cryptobox should be centered on the third tile from the perimeter side closest to the audience. From the audience view, the RED should be placed on the right and the BLUE on the left.

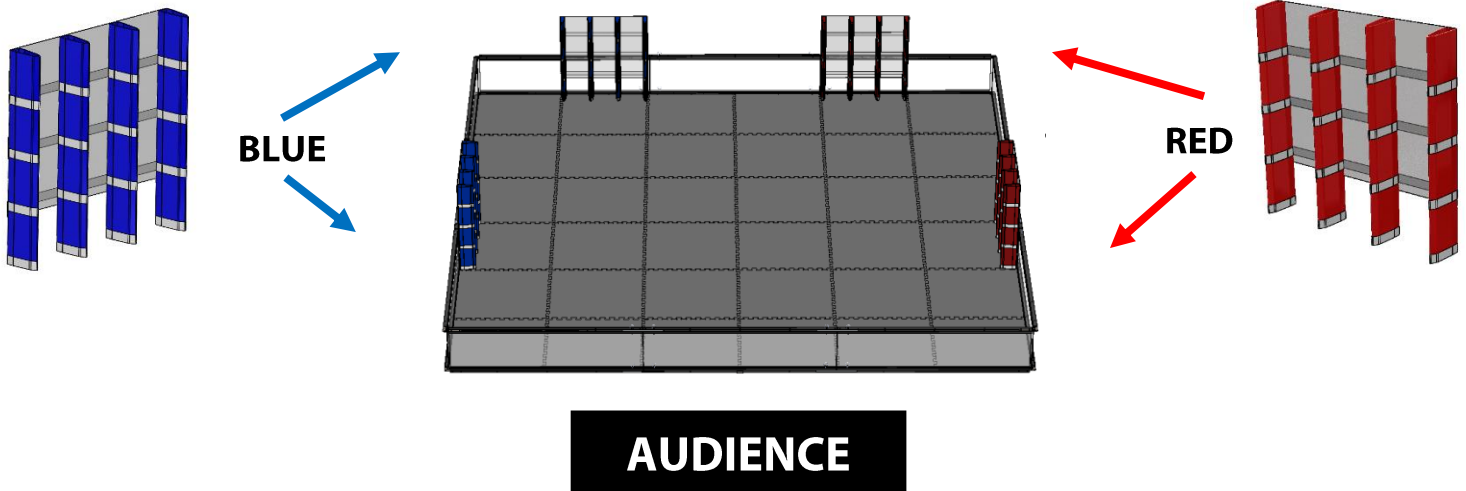

Step 3-1: Place two Lower Clips around the bottom of the field perimeter rail with the longer tab on the inside of the perimeter. The clips will secure the center two extrusions on the Cryptobox to the perimeter.

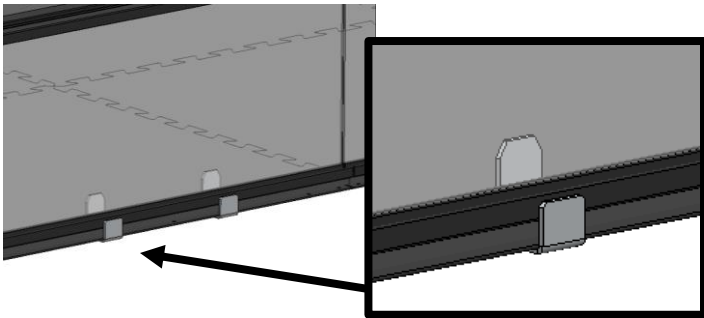

Step 3-2: Lower the Cryptobox Assembly onto the two Lower Clips. The clips should fit on the inside of the center two extrusion pieces.

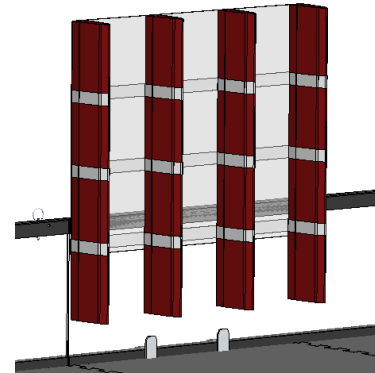

Step 3-3: Locate two Beam Clamp Assemblies and loosen the screws enough to fit over the field perimeter.

X2



Step 3-4: Place a Beam Clamp on either side of the Cryptobox with the screw on the outside of the perimeter for the AndyMark perimeter. Tighten the screw and nut to secure to the rail but be careful not to crush the rail.

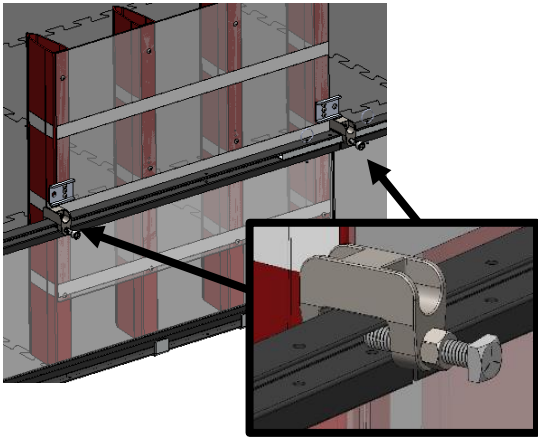

For IFI perimeters the screws should face downwards. Tighten the screw and nut to secure to the rail but be careful not to crush the rail.

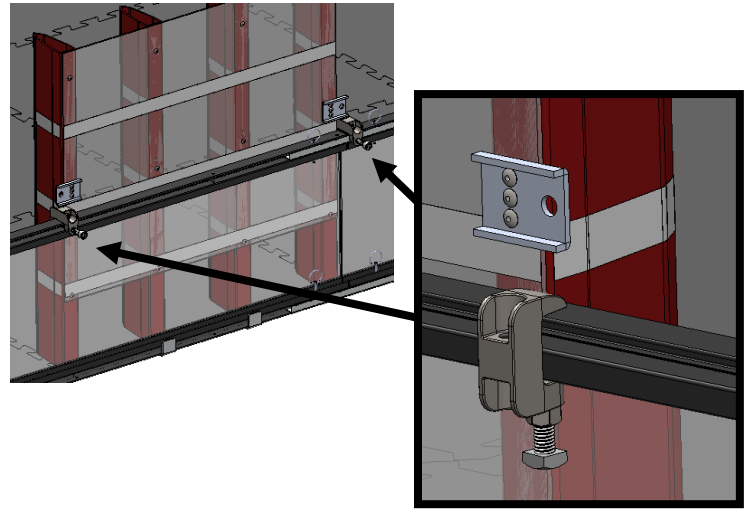

Step 3-5: Tightly secure the Cryptobox to the Beam Clamp using a cable tie.

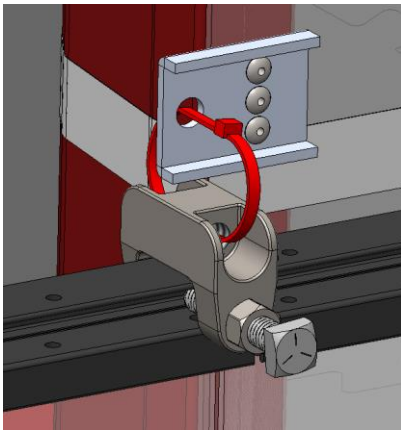

Step 3-6: Secure the remaining Cryptoboxes to the field perimeter. For additional field markings and taping diagrams please refer to Part 5 of this document.

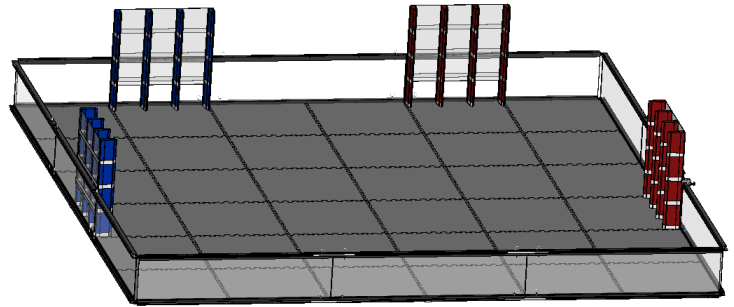

Part 4: Balancing Stone Placement

FIRST® RELIC RECOVERYSM is played with two RED and two BLUE Balancing Stones on the field. Build instructions can be found in the Field Assembly Guide.

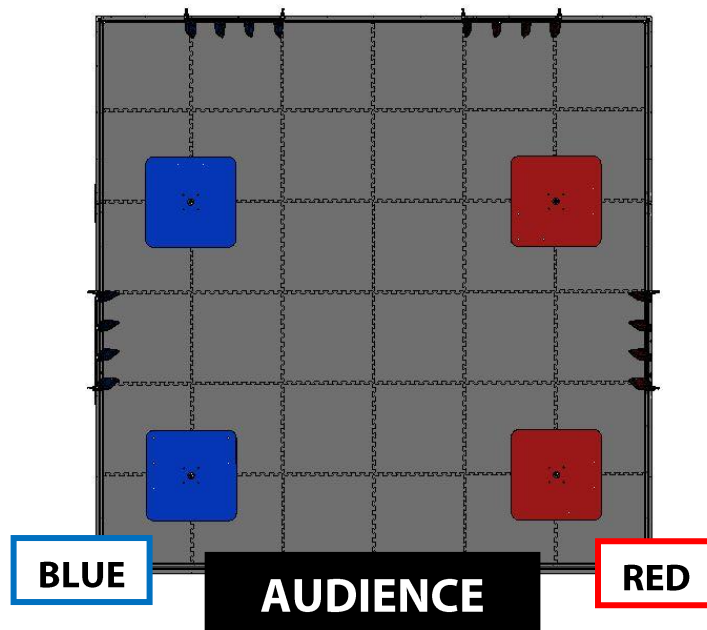

Step 4-1: Locate the Elevator Bolt, Disk, and 1.5" Standoff and assemble as shown below. Ensure the square portion of the Elevator Bolt is inserted into the Disk to sit as flat as possible.

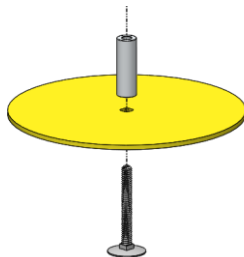

Step 4-2: At the intersection of four tiles, slide the disk portion of the assembly underneath.



Step 4-3 Optional: In order to allow the bolt to extend through the tile, trim the small corner extension on the fourth tile. Place that tile at the intersection.

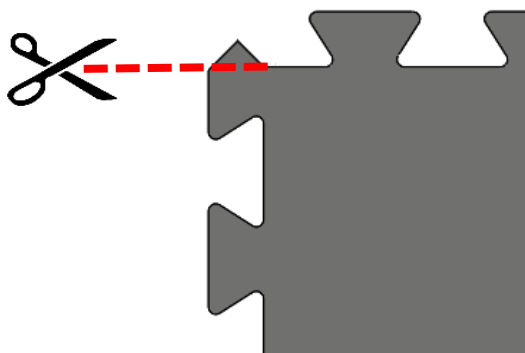

Step 4-4: Place the Balancing Stone onto the protruding elevator bolt.

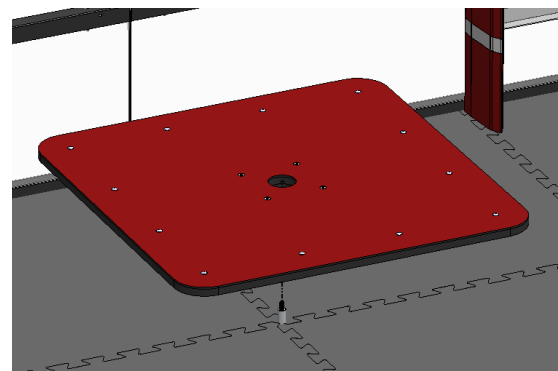

Step 4-5: Secure each Balancing Stone to the protruding bolt with a 1/4" washer and 1/4-20 nut. Tighten the nut until it hits the standoff.

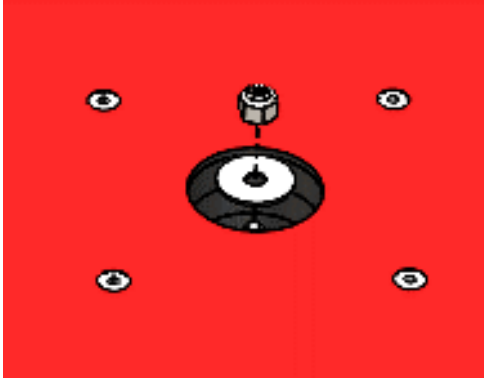

Step 4-6: Repeat for each Balancing Stone on the field. For additional field markings and taping diagrams please refer to section 5 of this document.

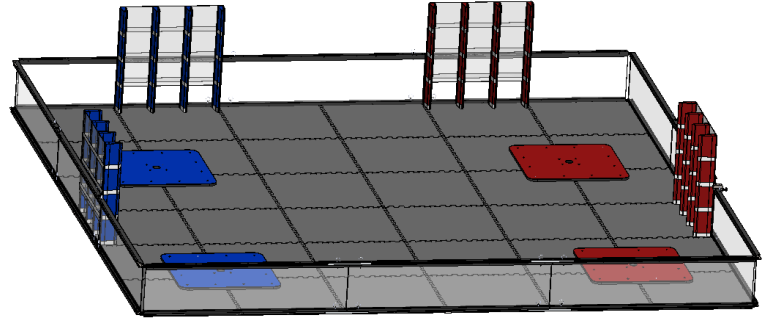

Part 5: Tape Lines

Step 5-1: Taping the Center Line:

Use 2" RED and BLUE Gaffers Tape on the center line. The location of the tape is as shown.

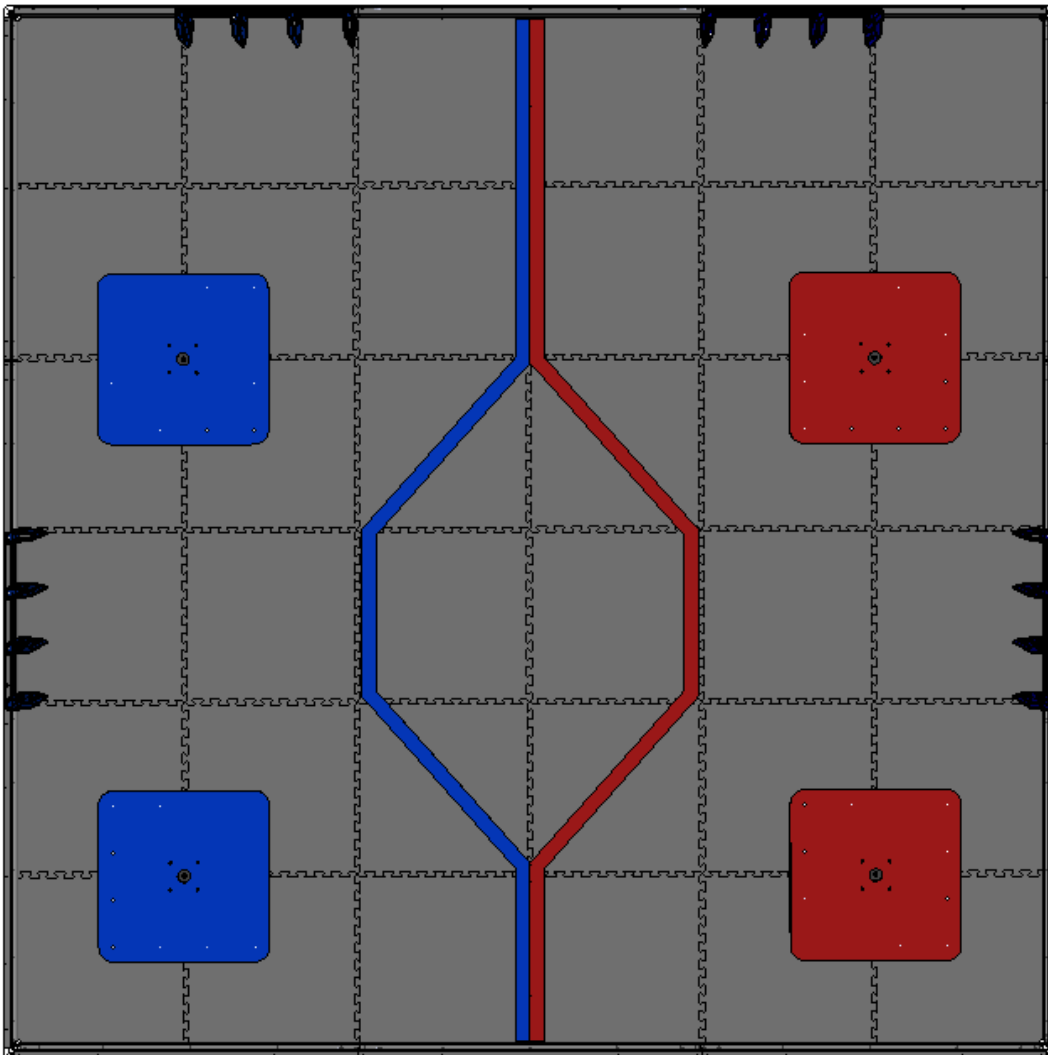

AUDIENCE

RED and BLUE tape should be placed one either side of the field center line and starting from the perimeter wall furthest from the audience and extending the length of two tiles. The tape should form 45 degree angles to form an elongated hexagon shape.

The long sides of the hexagon should have the outside of the tape touching the outside edge of the tile, not including the tile teeth.

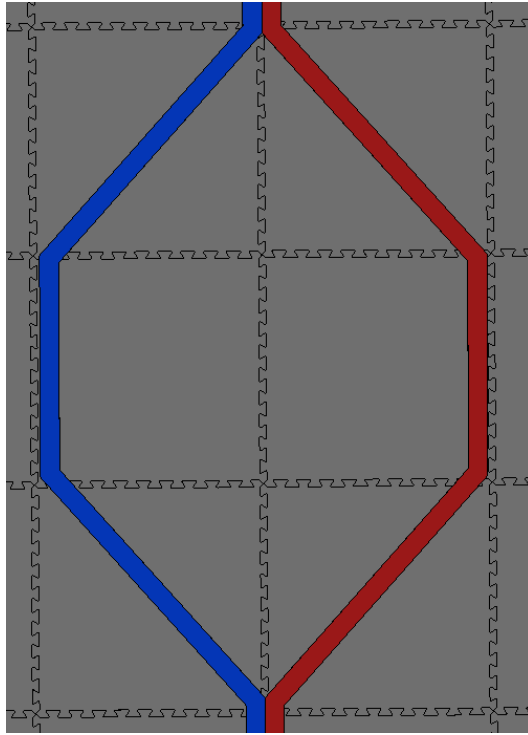

Step 5-2: Taping the Cryptobox Zones:

Each Cryptobox has a zone in front of it. Use 2" RED and BLUE Gaffers Tape on the Cryptobox Zones. The location of the tape is as shown.

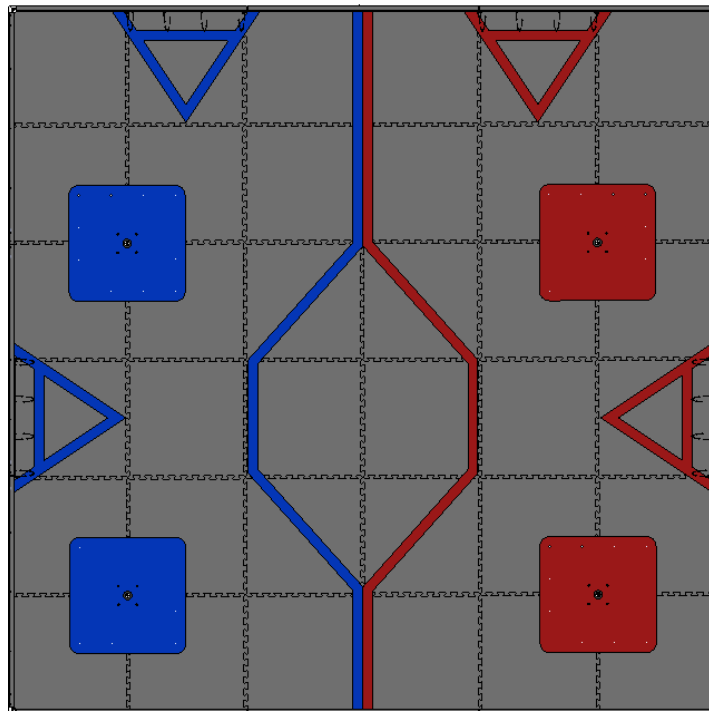

AUDIENCE

The Cryptobox Zone is centered on the Cryptobox. The outside edges of the tape at the widest section are 30 inches apart. The peak of the Zone should end at the tile border. A tape line parallel to the perimeter wall should be placed with its near edge 4 inches away from the perimeter wall. This piece should just touch the 4 tips of the Cryptobox Extrusions. It may be easiest to instal this piece of tape after the Cryptoboxes are placed on the field.

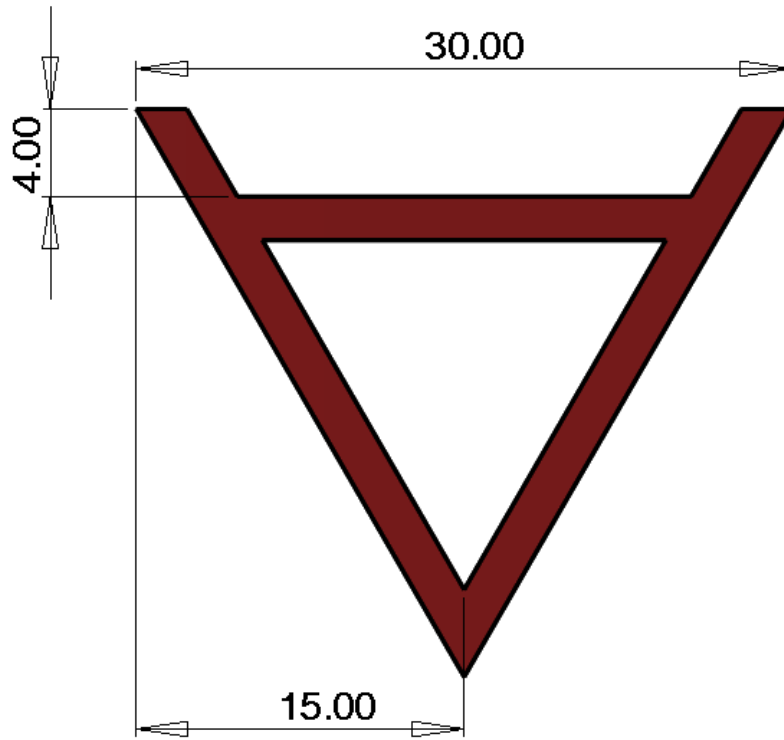

Step 5-3: Taping the Alliance Stations:

Use 2" RED and BLUE Gaffers Tape to mark the edges of the Alliance Stations on the floor outside the playing field as shown below. The RED alliance station should be on the right side when viewed from the audience. The BLUE alliance station should be on the left side when viewed from the audience.

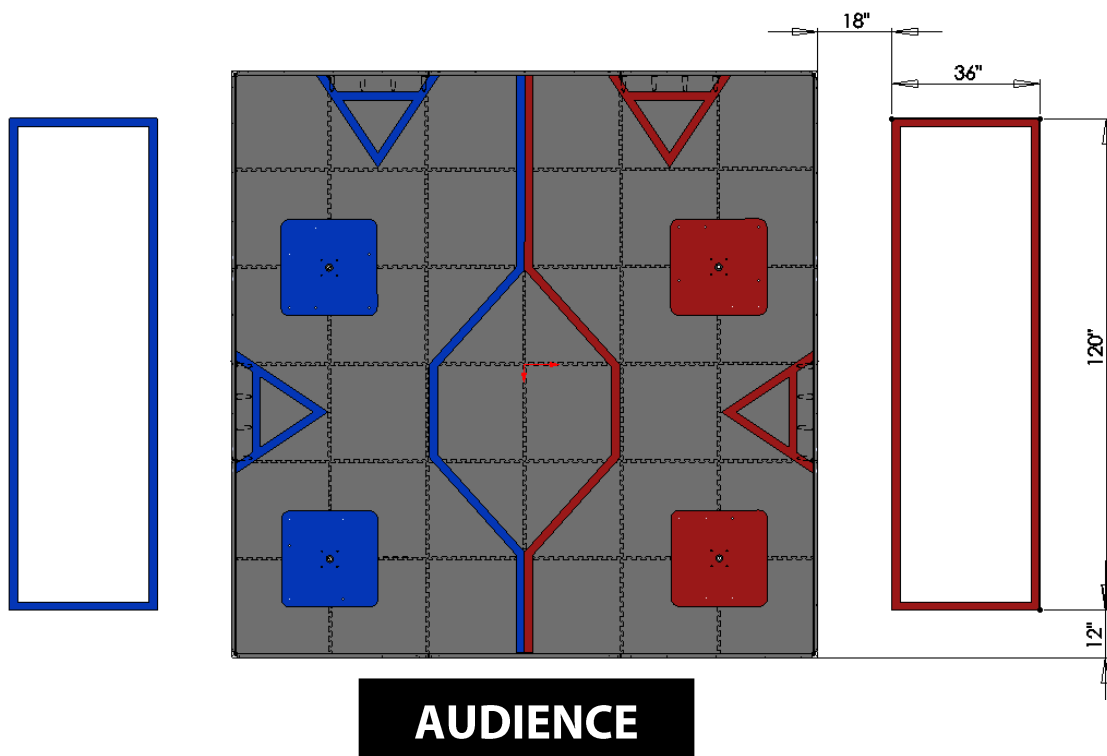

Part 6: Mat Layout

FIRST® RELIC RECOVERYSM is played with one RED and one BLUE Mat on the floor next to the field. The location is as shown.

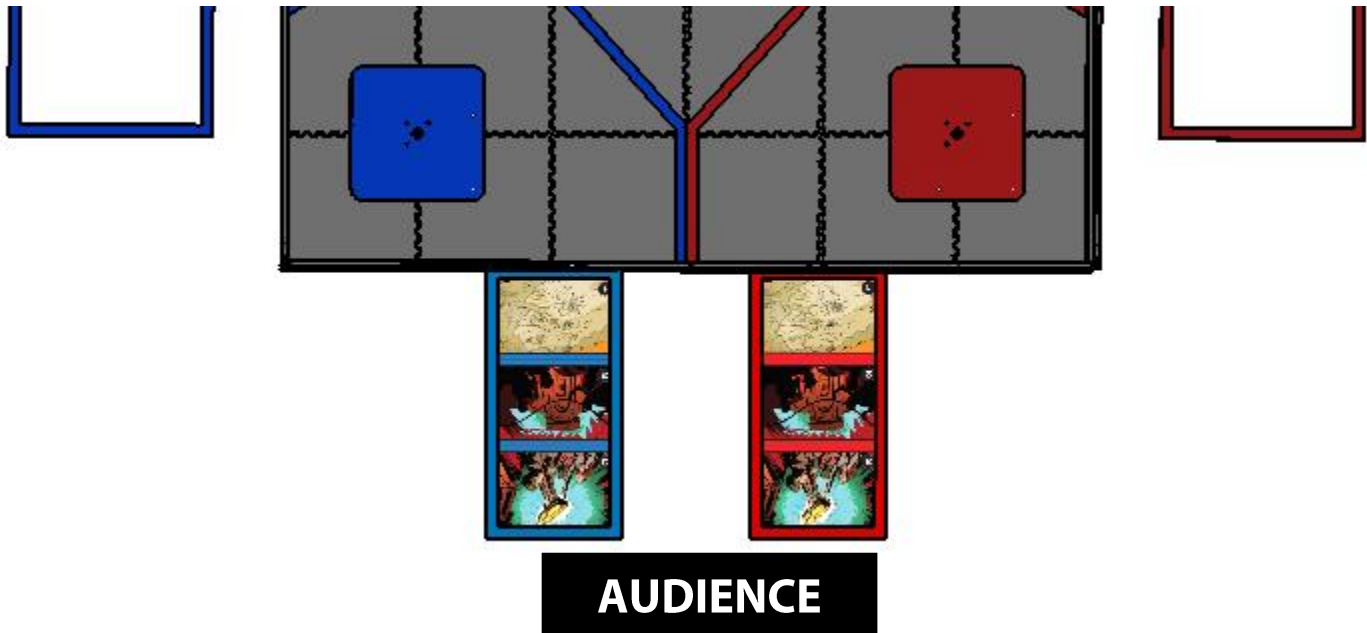

The RED mat should be placed on the right side when viewed by the audience. The BLUE mat should be placed on the left side when viewed by the audience. The "#1" zone should be placed closest to the perimeter. Each mat should be centered between the 2nd and 3rd tiles from the edge as shown.

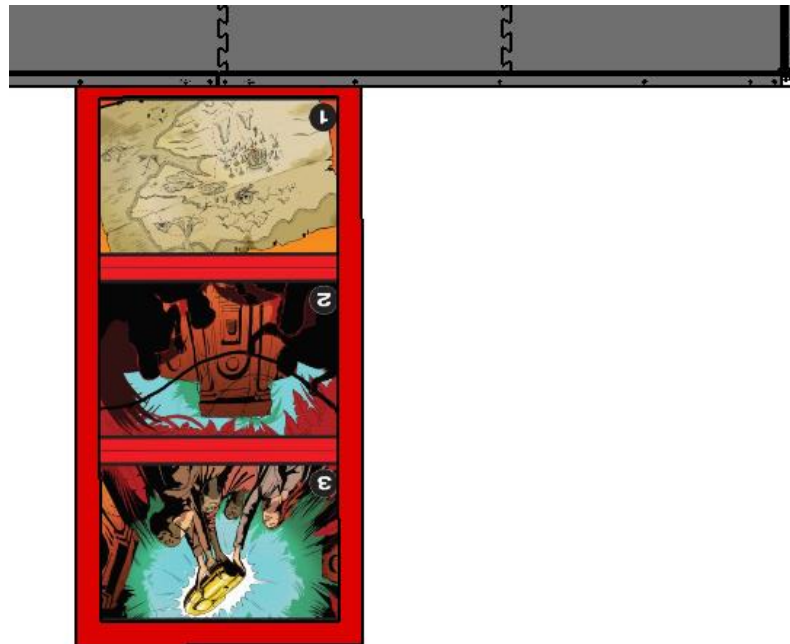

The outer edge of the mat can be taped to the floor with 2" Gaffers Tape. The tape should remain on the mats border and not cover any of the images, the images black border is considered apart of the image. In locations where taping to the floor is not allowed, non-skid pads can be used under the mat.

Part 7: Game Piece Placement

Step 7-1: Glyph Placement:

FIRST® RELIC RECOVERYSM is played with 24 gray and 24 brown Glyphs on the field. At the start of the match, the Glyphs should be randomly placed between the RED and BLUE center lines. The stack should not be more than 3 Glyphs tall.

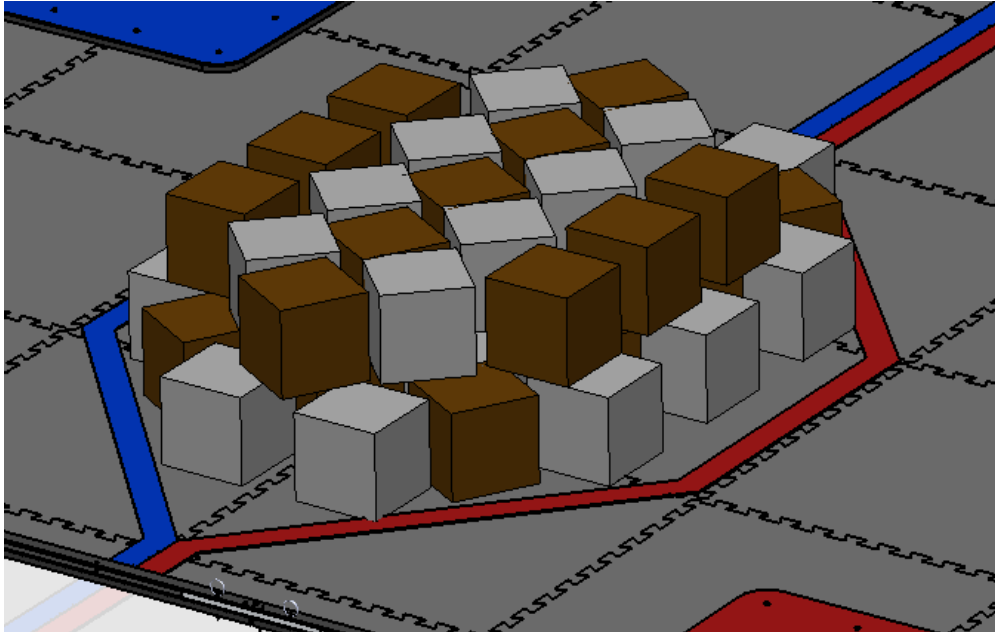

Step 7-2: Relic Placement:

Before each match, place a Relic in the corner of the field facing outwards. The RED Relics should be on the RED side of the field and the BLUE Relics should be on the BLUE side of the field. The arms of the Relic should be touching the adjacent walls.

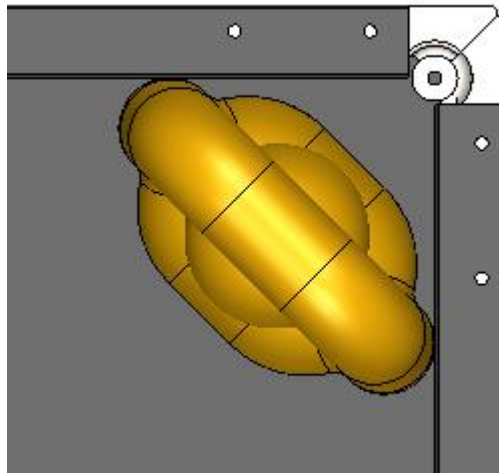
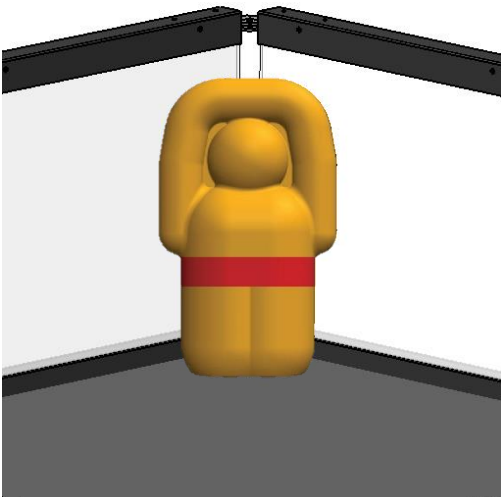

Step 7-3: Jewel Holders:

Jewel Holders are located against the perimeter sides adjacent to each Balancing Stone as shown.

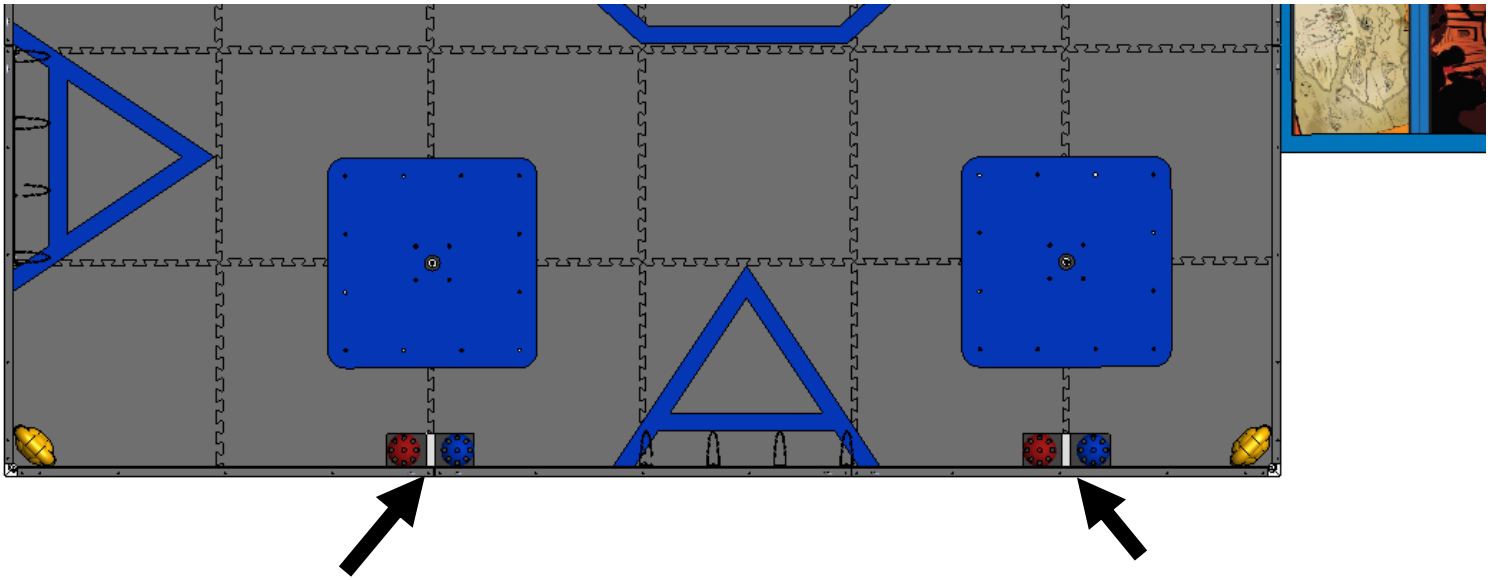

The center of the Jewel Holder should be centered with the Balancing stone. At the start of the match a RED and BLUE Jewel will be placed randomly on each side as per the game manual rules.

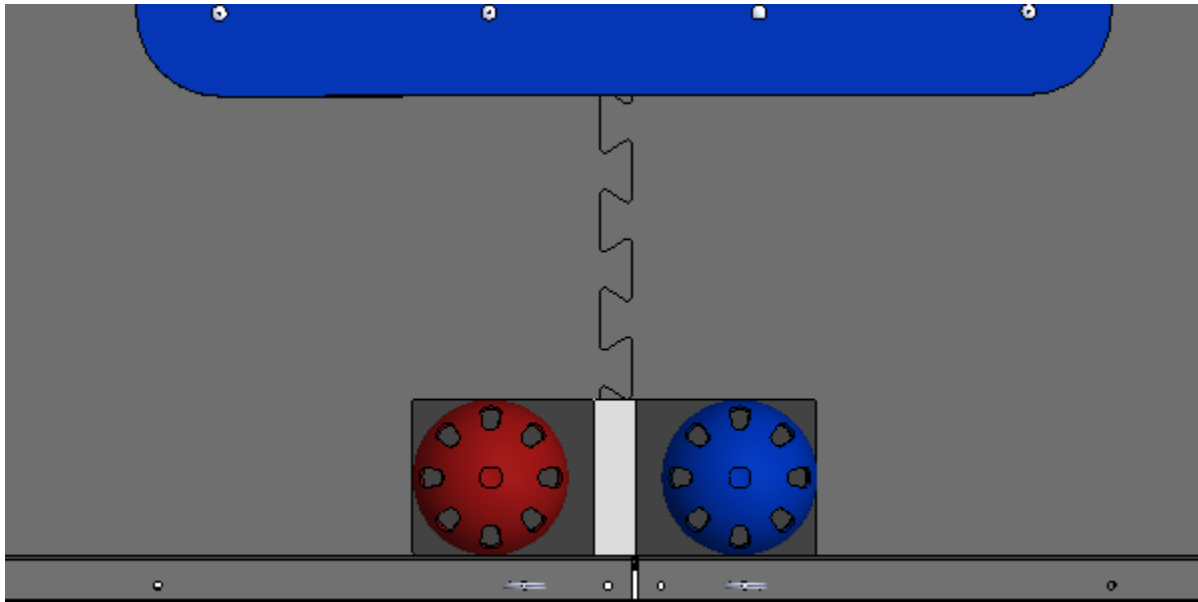

Part 8: Vision Targets

Step 8-1: Download Target Images found on the *FIRST* Tech Challenge Game and Season Info Page:
<http://www.firstinspires.org/resource-library/ftc/game-and-season-info>

Step 8-3: The target images should be placed 3" to the left of center from each Balancing Stone when viewed from inside the field. For the RED Balancing Stones, the target should be approximately 43 3/4" and 26 1/4" from the inside edge of the perimeter. The BLUE Balancing Stone targets should be approximately 49 3/4" and 20" from the inside edge of the perimeter. The bottom of the target should be 1 1/2" from the floor.

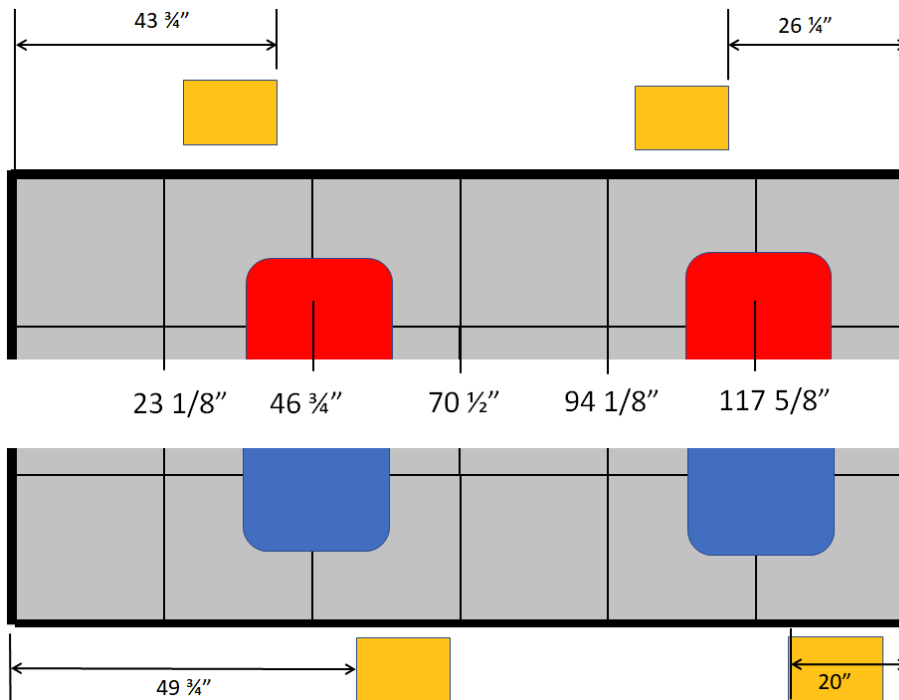

For AndyMark, IFI and LogoLoc perimeters, targets can be hung in place with Command Adhesive Mini Hooks. For early generation AndyMark Perimeters, use Velcro Dots to hang the targets.

Step 8-4: Print the three letters in black Landscape Orientation on 8.5x11" White Cardstock. The letters should be centered and cover the nearly the entire page. This image should be on the reverse of the target image. <http://www.firstinspires.org/resource-library/ftc/game-and-season-info>

Step 8-5: Insert both images (target and ID Letter) into the sheet protector sleeves and hang each from the Command Hooks or Velcro dots.

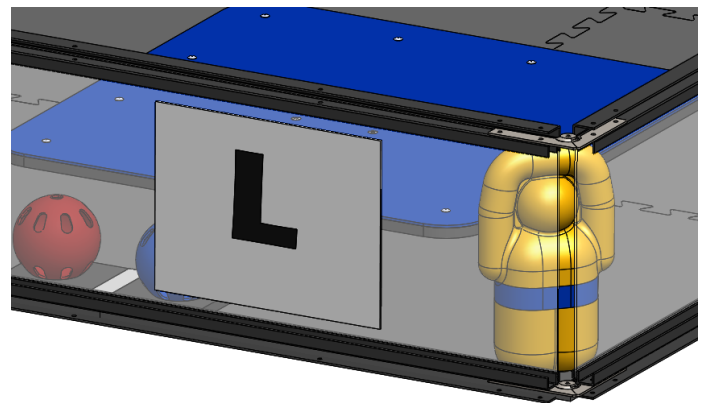

Part 9: Competition Area Components and Placement

Stands for Driver Station

With the introduction of the Android platform, the Competition Field will now have the added component of the Driver Station phone along with the game pads for each Team. Since the two Drivers on each Team will need to hold their gamepads when competing, there is a need for solutions on where Teams can place their Driver Station.

This section provides a recommendation (not a requirement) for a solution to placement of the Driver's Station.

Recommended Stands for Driver Stations

It is recommended that the Affiliate Partners and Event Directors provide a stand for teams to place their Driver Station.

One option is to provide Clever Crates used underneath the ramps in the 2014-2015 game Cascade Effect.



Alternative Stands

Affiliate Partners and Event Directors are encouraged to use the type of stand that works best for them and is readily available. We encourage you to come up with creative solutions; however, we also encourage you to steer clear of using metal stands, as these could block the signal from the Driver Station to the Robot Controller. Tables are not a viable option if they are set up in an orientation that blocks the Team's ability to see the Field or their Robot. This also hinders the sightlines for the FTA and Referees on the Field.

It is the responsibility of the Affiliate Partner or Event Director to provide stands for Teams. Teams cannot bring their own stands, tripods, etc. to the Competition. Teams must use the stands provided at the Event.

Drivers Station Customization for Teams

Each team provides their own Drivers Station consisting of an Android device, USB hub, and two Gamepads to control their Robot during match play. Most teams carry their loose electronics while some teams mount their Driver Station equipment in a carrying case or on a console. If Affiliate Partners or Event Directors provide Driver Station stands for teams they should accommodate both loose and mounted electronics.

Feedback

We'd like to hear all of your creative solutions! Please send them to ftcteams@firstinspires.org. Pictures are always helpful.

Referee Question Box

The Referee Question Box is a place where Teams can ask questions of the Referees after a Match.

The Referee Question Box must be placed in the Competition Area in a location where it will not interfere with the current running Matches, but close enough that the Referees will be able to see a student waiting at the Question Box. The Question Box can be as simple as a 3ft Gaffers Tape square on the floor.



Part 10: Match Timer Display

A Match Timer Display has been integrated into the Scoring System to be used as a visual and audible aid to Teams on where they are in a Match. Even though the Match Timer Display is integrated into the Scoring System, the two roles are independent of one another.

Equipment and Program Needed

- Laptop/Netbook
 - Copy of the current Scoring System installed
- Field Display Monitor
- Power
 - For Laptop
 - For Monitor
- VGA or video cable
 - To connect the laptop to the monitor
- Speakers

Scoring System Download and Installation

The Scoring System will require Java 1.7 or higher. The application can be downloaded from:

- www.java.com

The Scoring Software is available for download from:

- <http://www.firstinspires.org/node/5146>. To install the software, unzip the downloaded file into the folder of your choice. *FIRST* suggests that users save the file to the computer's desktop to easily access the program. The software will be run from this directory.

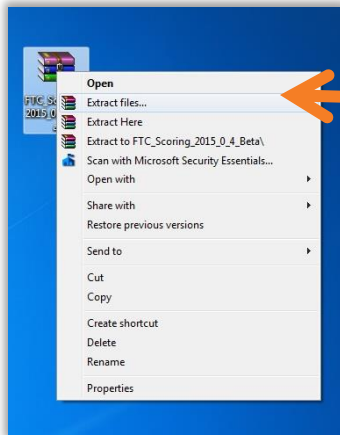

After downloading the software from the website, you will need to unzip the file. Right click the zipped file, and extract the files.

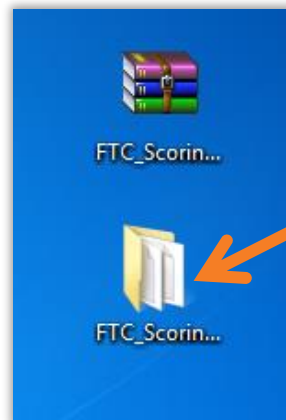

Once the files have been extracted, a new icon should appear. Double click this icon to open the file.

Name	Date modified	Type	Size
Import_Templates	11/4/2012 7:50 AM	File folder	
log	8/24/2015 1:15 PM	File folder	
matchmaker_MacOSX	7/10/2012 7:45 PM	File folder	
matchmaker_Win32	8/24/2015 10:57 AM	File folder	
Referee Sheets	11/19/2014 8:01 PM	File folder	
strings	8/22/2015 11:46 AM	File folder	
FTCScoring	8/22/2015 11:46 AM	Executable Jar File	23,596 KB
FTCScoring.properties	8/24/2015 11:44 AM	PROPERTIES File	1 KB
matches	8/24/2015 1:15 PM	Text Document	0 KB
README	4/21/2015 9:43 PM	Text Document	4 KB
RunFTCScoring	1/24/2014 9:07 PM	Windows Batch File	1 KB

To run the system, double click the "FTCScoring" executable Jar File. This will open up the main page of the Scoring System.

Using the Software

Step 10-1: To run the Match Timer Display, click on the “Match Timer Display” button from the main Scoring system page.

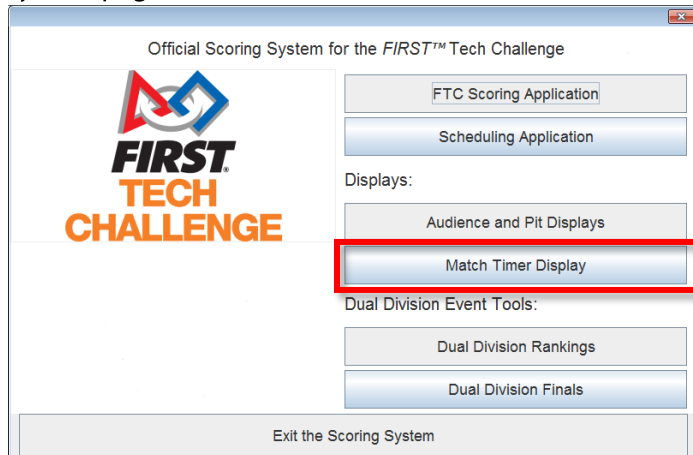

Step 10-2: In order to fit the Match Timer Display to the monitor it will be projected onto, select the appropriate screen resolution.

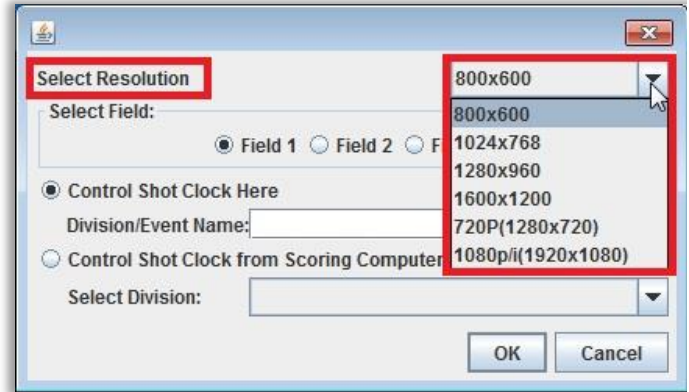

Step 10-3: Next make sure “Control Shot Clock Here” is selected, type in the name of the Event, and click “OK”.

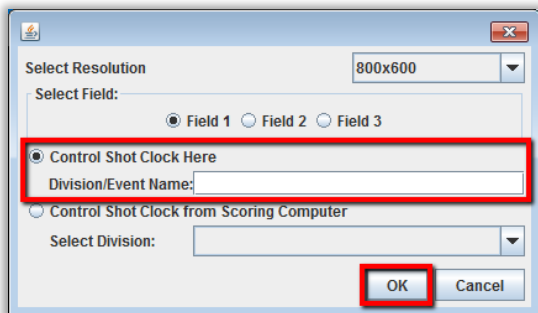

Step 10-4: After clicking “OK”, the Match Timer Display will appear, along with the Match Timer control box.

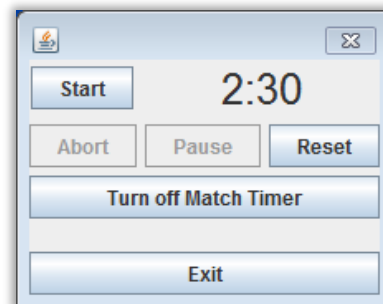

Using the Match Display Timer

The Match Timer Display Volunteer will work with the Game Announcer to start the clock as the Game Announcer announces the “3-2-1-GO!” countdown. The Volunteer will click the “Start” button on the Match Timer control box to start the clock. A separate Volunteer does not need to be recruited for this position; this can be done by a Referee, Head Referee, FTA, or Field Reset Volunteer.

There should be a Scorekeeper running the Scoring System and entering scores. The person running the Match Timer Display will NOT need to enter scores; rather they will only need to start the Timer at the beginning of each match and at the beginning of the Driver-Controlled period of the Match.