

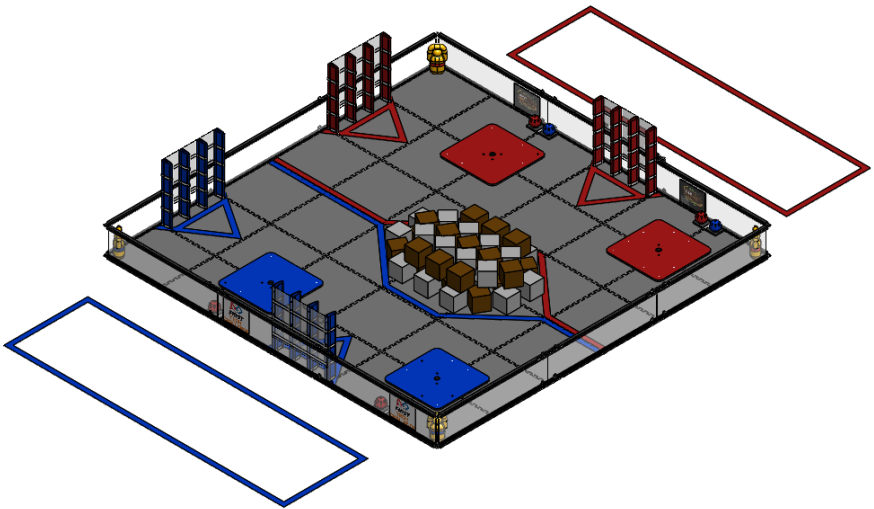

2017-2018 *FIRST*[®] Tech Challenge Field Assembly Guide

Rev 1.0



AndyMark[®] Field Components for 2017-2018 *FIRST*[®] Tech Challenge

This guide contains instructions for assembling the Field Elements for the 2017-2018 **FIRST®** Tech Challenge Game

FIRST RELIC RECOVERYSM Presented by Qualcomm® Inc.



Read through all the instructions and take inventory before you begin to assemble the game elements!

REVISION HISTORY

Rev.	Date	Description
1.0	8/16/17	Initial release



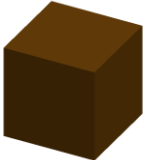







**ASSEMBLY VIDEOS CAN BE FOUND ON OUR WEBSITE:
AndyMark.com/FTCVideo**

GAME PIECES and ELEMENTS



Component	Part #	QTY	Part Photo
Relic	am-3570	4 per field	
Gray Glyph	am-3573	24 per field	
Brown Glyph	am-3574	24 per field	
RED Jewel	am-3364R	4 per field	
BLUE Jewel	am-3364B	4 per field	
RED Mat	am-3592R	1 Mat per field	
BLUE Mat	am-3592B	1 Mat per field	
Jewel Holder	am-3593	4 per field	

See Field Setup Guide for placement information.

TOOLS NEEDED

Component	QTY	Part Photo
Safety Equipment		
Rivet Tool	1	
3/8" Nut Driver or Socket	1	
7/16" Nut Driver or Socket	1	
1/8" Hex Key Driver	1	
Cutters	1	
3/8" Wrench	1	
9/16" Wrench	1	
File	1	
Utility Knife	1	
25' Tape Measure	1	
Rubber Mallet	1	

ADDITIONAL REQUIRED ITEMS

1" White Gaffers Tape	1	
2" RED Gaffers Tape	1	
2" BLUE Gaffers Tape	1	

Tools and tape can be purchased as a set from AndyMark







ADDITIONAL TOURNAMENT ITEMS

Purchased or Sourced Separately

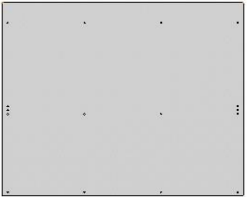
<p>Cardstock for Vision Targets (Printed from <i>FIRST</i> Resource Library)</p>	<p>24</p>	
<p>Command Mini Hooks P/N: 17006-VP For use with AndyMark, IFI and Logo Loc Perimeters</p>	<p>8</p>	
<p>Velcro® Dots Roughly 3/4" diameter or larger For use with early generation AndyMark Perimeters</p>	<p>1 pack</p>	
<p>Clear Page Protection Sleeves</p>	<p>12</p>	
<p>Non Skid pad (for Mats when taping to floor isn't allowed, 3x5ft is suggested)</p>	<p>2</p>	
<p>6 sided Die (A marked up Glyph will also work)</p>	<p>1</p>	

CRYPTOBOX

NOTE: Two RED and two BLUE Cryptoboxes are needed per field. Below lists the QTY needed for each Cryptobox.

Component	Part #	QTY	Part Photo
Rail Extrusion RED or BLUE	am-3204R or am-3204B	4	
Back Panel	am-3584	1	
Hardware Pack			
1/8" Rivet	am-2835_Rivet	16	
Beam Clamp	am-3177	2	
Cable Tie Bracket	am-3585	2	
Cable Tie (extras included, additional will be needed for future setups)	am-1067	2	
Lower Clip	am-3586	2	













CAUTION!

Edges of field parts may be sharp. File or deburr sharp corners or edges as needed.

BALANCING STONE

NOTE: Two RED and two BLUE Balancing Stones are needed per field.
Below lists the QTY needed for each Balancing Stone.

Component	Part #	QTY	Part Photo
Stone Plate	am-3587	1	
Stone Top Panel RED or BLUE	am-3588R or am-3588B	1	
Upper Pylon	am-3589	2	
Lower Pylon	am-3590	1	
Disk	am-2835_Disk	1	
Hardware Pack			
10-32 x 2.00" Countersunk Screw	am-1383	4	
10-32 Nylock Jam Nut	am-1063	4	
Large 1/4" Washer	am-1421	1	
1.5" Standoff	am-3591	1	
Elevator Bolt (anchor)	am-1384	1	
1/4-20 Nylock Nut	am-1015	1	
Small 1/8" Washer	am-1345	12	
1/8" Rivet	am-2835_Rivet	12	

Cryptobox Assembly Instructions

FIRST RELIC RECOVERYSM is played with two RED and two BLUE Cryptoboxes on the field.

Step 1-1: Remove the white or clear protective film from both sides of the Back Panel.

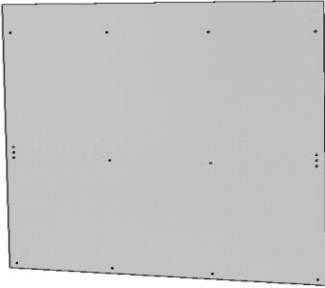

Step 1-3: Arrange the Rail Extrusions and Back Plate as shown. The top edge of the Back Panel should align with the edge of the extrusion.

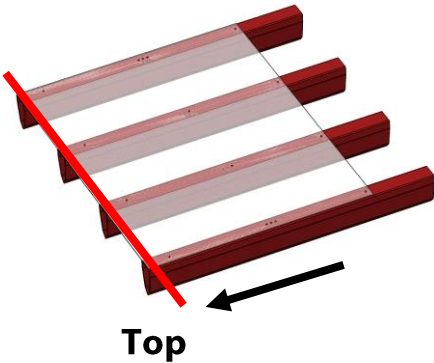

Step 1-2: Locate four RED or four BLUE Rail Extrusions. All of the extrusions are the same, but the holes are not symmetrical. Take note of where the holes are located on the Rail Extrusions and the Back Panel.

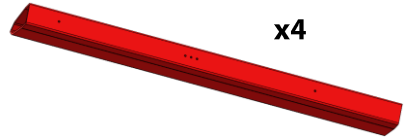

Step 1-4: Insert rivets through the Back Panel and the extrusions in the following locations. The center holes on the outer rails need to be unriveted.

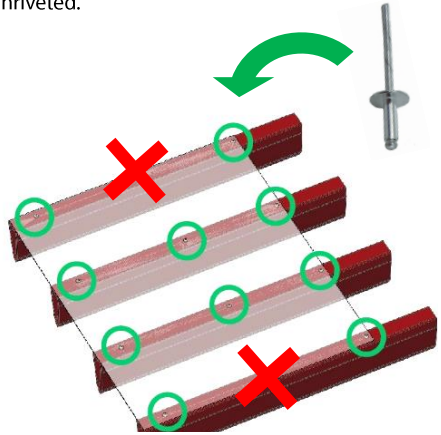

Step 1-5: Ensure that the Back Panel is aligned and secure each rivet using a rivet tool. Place the pin of the rivet into the hole in the rivet tool and squeeze the handle together until you hear a snapping sound. The rivet pin will detach from the rivet and the two pieces will be secured together.



Step 1-6: Locate Cable Tie Brackets and align with the center holes on the outer extrusions. The bracket should sit flat against the Back Plastic and the Cable Tie hole should face outwards.

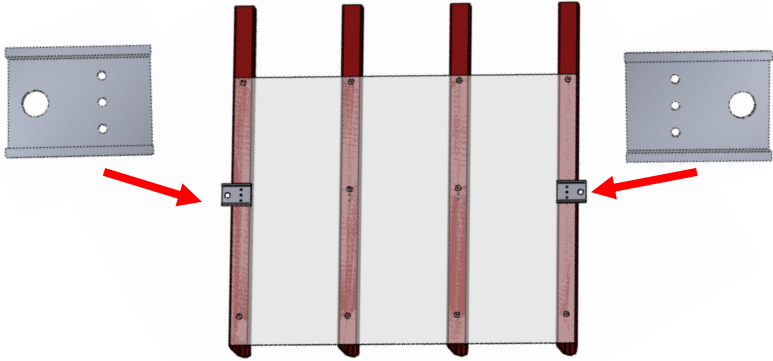

Step 1-7: Using rivets, secure each Cable Tie Bracket to the extrusions. Use three rivets per bracket.

Step 1-8: For a full field setup, repeat steps 1-1 to 1-7 for each remaining Cryptobox.



**x3 per
bracket**



Step 1-9: On the back flat surface, three lines of 1" white gaffers tape should be added. The bottom edge of the tape should sit at 6, 12, and 18" measured from the bottom edge. The line extends across the full width of the Cryptobox.

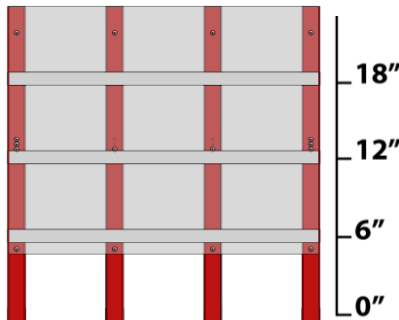

Step 1-10: On the front side of the Cryptobox, four rows of 1" white gaffers tape should be applied to each Rail. The bottom edge of the tape should sit at 0, 6, 12, and 18" from the bottom edge. Each section of tape should wrap around both sides of the Rail

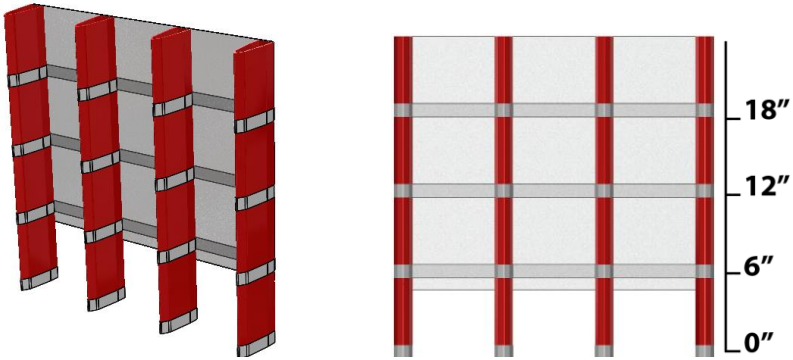

Step 1-11: On the competition field there are two RED and two BLUE Cryptoboxes on the field. The orientation is shown below. See the *FIRST* RELIC RECOVERYSM Field Setup Guide for exact placement.

Audience Side

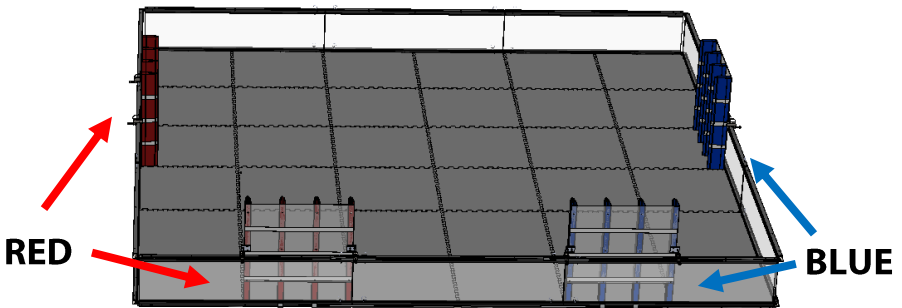

Step 1-12: Place two Lower Clips around the bottom of the field perimeter rail with the longer tab on the inside of the perimeter. The clips will secure the center two extrusions on the Cryptobox to the perimeter.

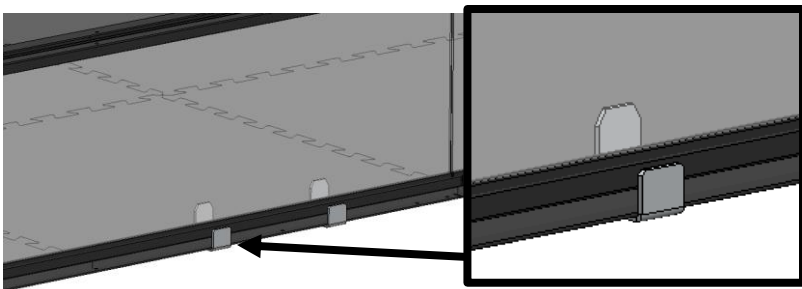

Step 1-13: Lower the Cryptobox Assembly onto the two Lower Clips. The clips should fit on the inside of the center two extrusion pieces.

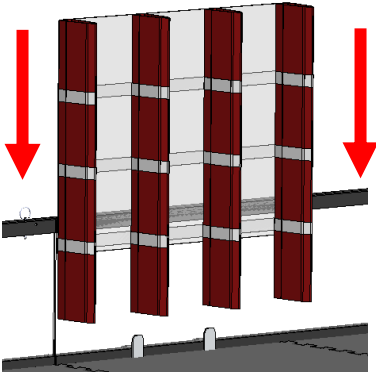

Step 1-15: Place a Beam Clamp on either side of the Cryptobox with the screw on the outside of the perimeter for the AndyMark perimeter. For IFI perimeters the screws should face downwards. Tighten the screw and nut to secure to the rail but be careful not to crush the rail.

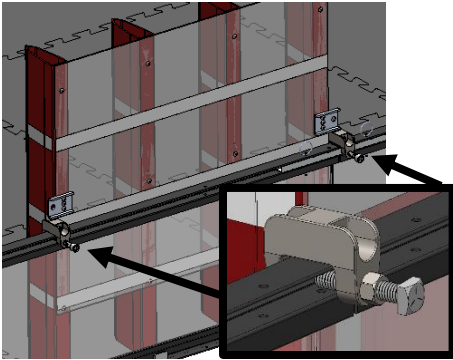

Step 1-14: Locate two Beam Clamp Assemblies and loosen the screws enough to fit over the field perimeter.



Step 1-16: Tightly secure the Cryptobox to the Beam Clamp using a cable tie.

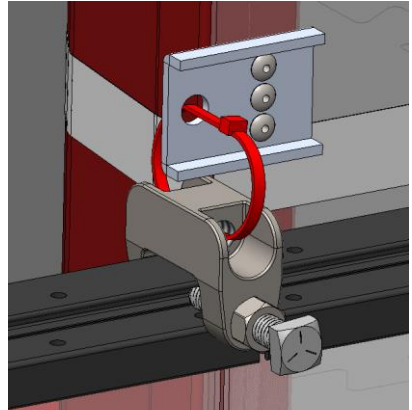

Step 1-17: Secure the remaining Cryptoboxes to the field perimeter. For additional field markings and tapping diagrams please refer to the [FIRST RELIC RECOVERYSM Field Setup Guide](#).

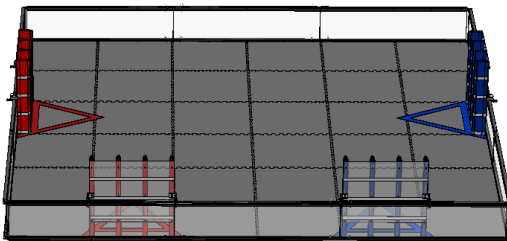

Balancing Stone Assembly

FIRSTRELIC RECOVERYSM is played with two RED and two BLUE Balancing Stones on the field.

Step 2-1: Remove the white or clear protective film from both sides of the RED or BLUE panels, and yellow disk.

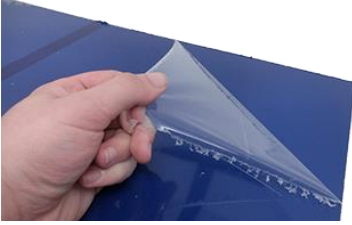

Step 2-2: Locate four 10-32 x 2.00" Countersunk Screws.



x4

Step 2-3: Stack the Stone Top Panel, Stone Plate, 2 Upper Pylons, and Lower Pylon as shown. Ensure that the Lower Pylon has the counterbore side facing downward and the Stone Top Panel has the counterbore facing upwards.

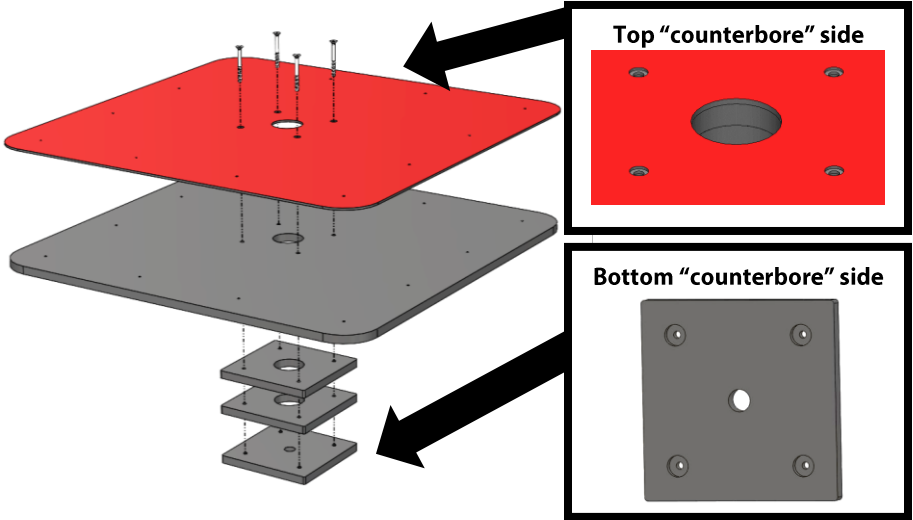

Step 2-4: Secure the stack together with the four 10-32 x 2.00" Screws and 10-32 Nylock nuts. Tighten until the heads of the screws are flat with the surface of the RED or BLUE panel and the nuts are flush with the inner bore of the bottom panel. Bolts may need to be temporarily loosened for step 2-5.

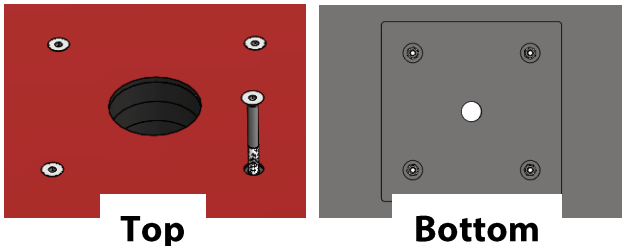

Top

Bottom

Step 2-5: Rivet around perimeter of the plates using washers on the black side. To ensure the holes align, it is helpful to insert the rivets into all the holes first and then use the rivet tool to secure.

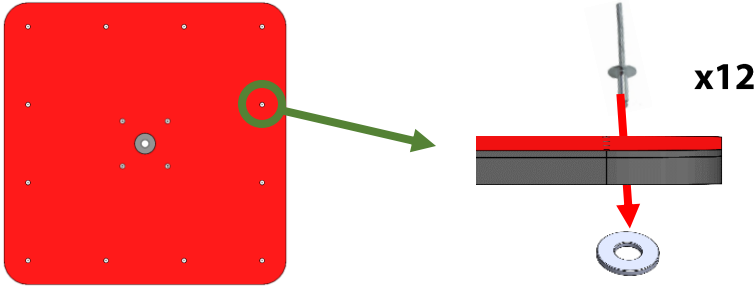

Step 2-6: The full field has two RED Balancing Stones and two BLUE Balancing Stones in the following locations on the field.

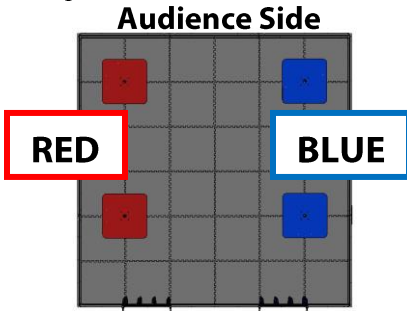

Step 2-7: Locate the Elevator Bolt, Disk, and 1.5" Standoff and assemble as shown below. Ensure the square portion of the Elevator Bolt is inserted into the Disk to sit as flat as possible.

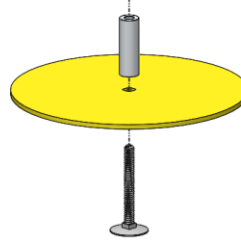

Step 2-8: At the intersection of four tiles, slide the disk portion of the assembly underneath.



Step 2-9 Optional: In order to allow the bolt to extend through the tile, trim the small corner extension on the fourth tile. And place that tile at the intersection.

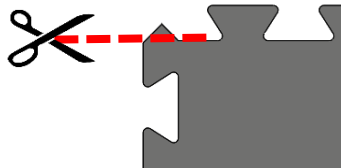

Step 2-10: Place the Balancing Stone onto the protruding elevator bolt.

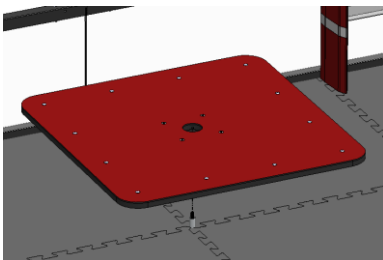

Step 2-11: Secure each Balancing Stone to the protruding bolt with a 1/4" washer and 1/4-20 nut.



Step 2-12 Repeat for each Balancing Stone on the field. For additional field markings and taping diagrams please refer to the [FIRST RELIC RECOVERYSM Field Setup Guide](#).

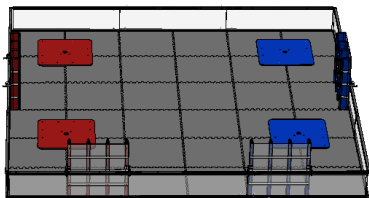

Relic and Jewel Preparation

FIRST RELIC RECOVERYSM is played with two RED and two BLUE Relics on the field. There are four RED and four BLUE Jewels on the field.

Step 3-1: For a competition field, mark two Relics with 1" RED Gaffers Tape strips and two Relics with 1" BLUE Gaffers Tape strips. The top of the tape should sit directly below the arms of the Relic and the bottom of the tape should be placed at the top of the legs. The tape should wrap around the whole Relic.

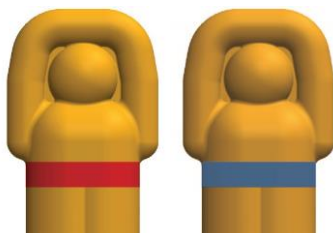

x2 each

Step 3-2: On a competition field, the Jewel Holder has a 1" strip of White Gaffers tape that divides it in half. One RED and one BLUE Jewel will sit on each of four Jewel Holders on the field. Details on exact placement of the Holders can be found in the Field Setup Guide.

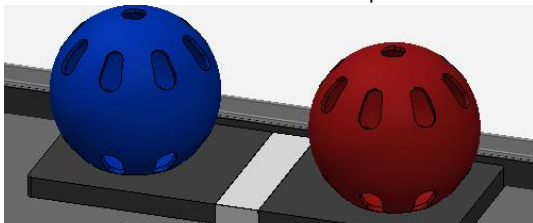

Additional hardware will be left over and used for attaching components to the field. Extra hardware should be kept and not discarded.

Additional instructions on the following can be found in the Field Setup and Configuration Guide Available on AndyMark.com/FTC

- Setting up the Floor and Field Perimeter
- Instructions for Field Layout and Orientation
- Tournament Setup

More resources on this year's challenge can be found on

<http://www.firstinspires.org/resource-library/ftc/game-and-season-info>